



LG

Website:<http://biz.LGservice.com>
E-mail:<http://www.LGservice.com/techsup.html>

COLOR MONITOR

SERVICE MANUAL

CHASSIS NO. : CA-109

FACTORY MODEL: CB777G

**MODEL: StudioWorks 700S (CB777G-NA), StudioWorks 700E (CB777G-AA)
StudioWorks 700B (CB777G-EA)**

***() ID LABEL Model No.**

CAUTION

**BEFORE SERVICING THE UNIT,
READ THE SAFETY PRECAUTIONS IN THIS MANUAL.**



CONTENTS

SPECIFICATIONS	2	DESCRIPTION OF BLOCK DIAGRAM.....	9
SAFETY PRECAUTIONS	3	ADJUSTMENT	11
TIMING CHART	4	TROUBLESHOOTING GUIDE	13
OPERATING INSTRUCTIONS	5	EXPLODED VIEW.....	23
WIRING DIAGRAM	6	REPLACEMENT PARTS LIST	25
DISASSEMBLY	7	PIN CONFIGURATION.....	30
BLOCK DIAGRAM	8	SCHEMATIC DIAGRAM.....	32
		PRINTED CIRCUIT BOARD.....	34

SPECIFICATIONS

1. PICTURE TUBE

- Size : 17 inch
- Deflection Angle : 90°
- Neck Diameter : 29.1 mm
- Dot Pitch : 0.27 mm
- Face Treatment : W-ARASC (Anti-Reflection and Anti-Static Coating)
- Low Radiation : MPR II, TCO 99

2. SIGNAL

- 2-1. Horizontal & Vertical Sync
 - 1) Input Voltage Level: Low=0~1.2V, High=2.5~5.5V
 - 2) Sync Polarity : Positive or Negative
- 2-2. Video Input Signal
 - 1) Voltage Level : 0 ~ 0.7 Vp-p
 - a) Color 0, 0 : 0 Vp-p
 - b) Color 7, 0 : 0.467 Vp-p
 - c) Color 15, 0 : 0.7 Vp-p
 - 2) Input Impedance : 75 Ω
 - 3) Video Color : R, G, B Analog
 - 4) Signal Format : Refer to the Timing Chart

- 2-3. Signal Connector
 - 3 row 15-pin Connector (Attached)

- 2-4. Scanning Frequency
 - Horizontal : 30 ~ 70 kHz
 - Vertical : 50 ~ 160 Hz

3. POWER SUPPLY

- 3-1. Power Range
 - AC 100~240V (Free Voltage), 50/60Hz, 2.0A Max.

3-2. Power Consumption

MODE	POWER CONSUMPTION	LED COLOR
MAX	85 W	GREEN
NORMAL (ON)	73 W	GREEN
STAND-BY	less than 15 W	AMBER
SUSPEND	less than 15 W	AMBER
OFF	less than 5 W	AMBER

4. DISPLAY AREA

- 4-1. Active Video Area :
 - Max Image Size - 326.7 x 245.5 mm (12.86" x 9.67")
 - Preset Image Size - 310 x 230 mm (12.20" x 9.06")
- 4-2. Display Color : Full Colors
- 4-3. Display Resolution : 1280 x 1024 / 60Hz(Max)
(Non-Interlace)
- 4-4. Video Bandwidth : 110 MHz

5. ENVIRONMENT

- 5-1. Operating Temperature: 0°C ~ 40°C
(Ambient)
- 5-2. Relative Humidity : 10%~ 90%
(Non-condensing)
- 5-3. Altitude : 5,000 m

6. DIMENSIONS (with TILT/SWIVEL)

- Width : 400.0 mm (15.74 inch)
- Depth : 420.0 mm (16.53 inch)
- Height : 395.0 mm (15.55 inch)

7. WEIGHT (with TILT/SWIVEL)

- Net Weight : 14.4 kg (31.75 lbs.)
- Gross Weight : 17.0 kg (37.48 lbs.)

SAFETY PRECAUTIONS

SAFETY-RELATED COMPONENT WARNING!

There are special components used in this color monitor which are important for safety. **These parts are marked  on the schematic diagram and the replacement parts list.** It is essential that these critical parts should be replaced with the manufacturer's specified parts to prevent X-radiation, shock, fire, or other hazards. Do not modify the original design without obtaining written permission from manufacturer or you will void the original parts and labor guarantee.

CAUTION: No modification of any circuit should be attempted.

Service work should be performed only after you are thoroughly familiar with all of the following safety checks and servicing guidelines.

SAFETY CHECK

Care should be taken while servicing this color monitor because of the high voltage used in the deflection circuits. These voltages are exposed in such areas as the associated flyback and yoke circuits.

FIRE & SHOCK HAZARD

An isolation transformer must be inserted between the color monitor and AC power line before servicing the chassis.

- In servicing, attention must be paid to the original lead dress specially in the high voltage circuit. If a short circuit is found, replace all parts which have been overheated as a result of the short circuit.
- All the protective devices must be reinstalled per the original design.
- Soldering must be inspected for the cold solder joints, frayed leads, damaged insulation, solder splashes, or the sharp points. Be sure to remove all foreign materials.

IMPLOSION PROTECTION

All used display tubes are equipped with an integral implosion protection system, but care should be taken to avoid damage and scratching during installation. Use only same type display tubes.

X-RADIATION

The only potential source of X-radiation is the picture tube. However, when the high voltage circuitry is operating properly there is no possibility of an X-radiation problem. The basic precaution which must be exercised is keep the high voltage at the factory recommended level; the normal high voltage is about 25.5kV. The following steps describe how to measure the high voltage and how to prevent X-radiation.

Note : It is important to use an accurate high voltage meter calibrated periodically.

- To measure the high voltage, use a high impedance high voltage meter, connect (-) to chassis and (+) to the CDT anode cap.
- Set the brightness control to maximum point at full white pattern.
- Measure the high voltage. The high voltage meter should be indicated at the factory recommended level.
- If the meter indication exceeds the maximum level, immediate service is required to prevent the possibility of premature component failure.
- To prevent X-radiation possibility, it is essential to use the specified picture tube.

CAUTION:

Please use only a plastic screwdriver to protect yourself from shock hazard during service operation.

TIMING CHART

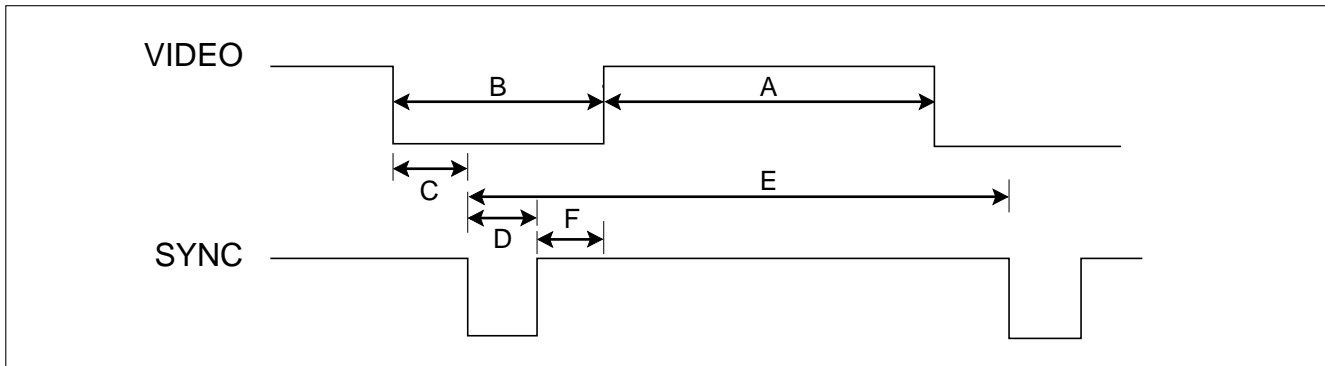

<< Dot Clock (MHz), Horizontal Frequency (kHz), Vertical Frequency (Hz), Horizontal etc... (μs), Vertical etc... (ms) >>

Mode	H/V Sort	Sync Polarity	Frequency	Total Period (E)	Video Active Time (A)	Blanking Time (B)	Sync Duration (D)	Back Porch (F)	Front Porch (C)	Resolution
1	H	-	37.50	26.67	20.32	6.35	2.03	3.81	0.51	640x480 75Hz
	V	-	74.99	13.335	12.802	0.533	0.080	0.427	0.026	
2	H	+	46.88	21.33	16.16	5.17	1.62	3.23	0.32	800x600 75Hz
	V	+	75.01	13.331	12.798	0.533	0.064	0.448	0.021	
3	H	+	53.68	18.63	14.22	4.41	1.14	2.70	0.57	800x600 85Hz
	V	+	85.07	11.755	11.178	0.577	0.056	0.503	0.018	
4	H	+	68.677	14.561	10.836	3.725	1.016	2.201	0.508	1024x768 85Hz
	V	+	85.00	11.764	11.182	0.582	0.044	0.524	0.014	

* Mode 1~Mode 4: Basic Mode

OPERATING INSTRUCTIONS

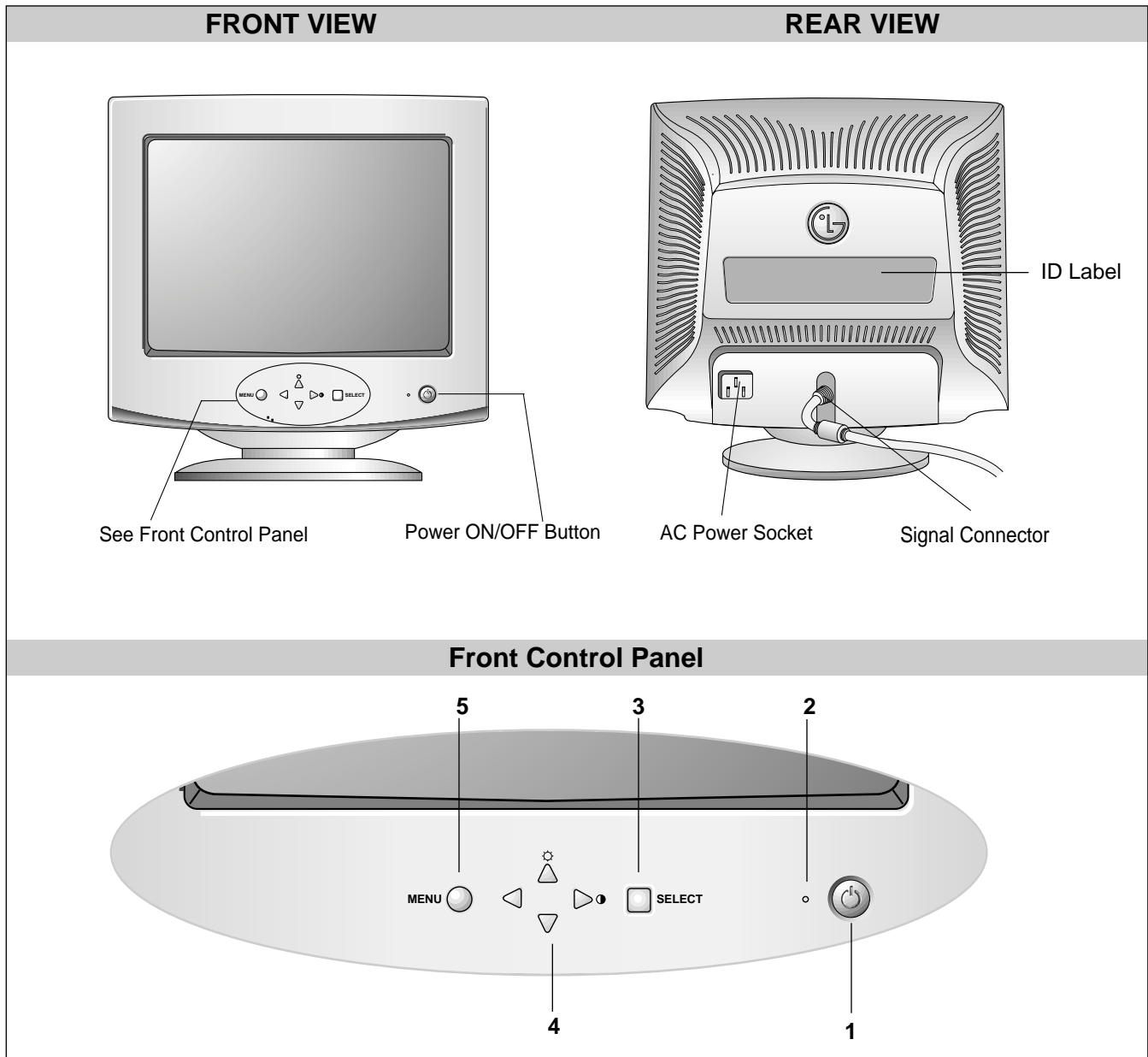

1. Power ON/OFF Button

Use this button to turn the monitor ON or OFF.

2. Power Indicator

This indicator lights up green when the monitor operates normally; in DPMS (Energy Saving) mode, -stand-by, suspend, or power off mode -its color changes to orange, and if abnormal or damaging circuit turns out orange blink.

3. Select Button

Use this button to enter a selection in the on screen display.

4. $\Delta \nabla / \triangle \square$ Button

Use these buttons to choose or adjust items in the on screen display.

5. MENU Button

Use this button to enter or exit the on screen display.

WIRING DIAGRAM

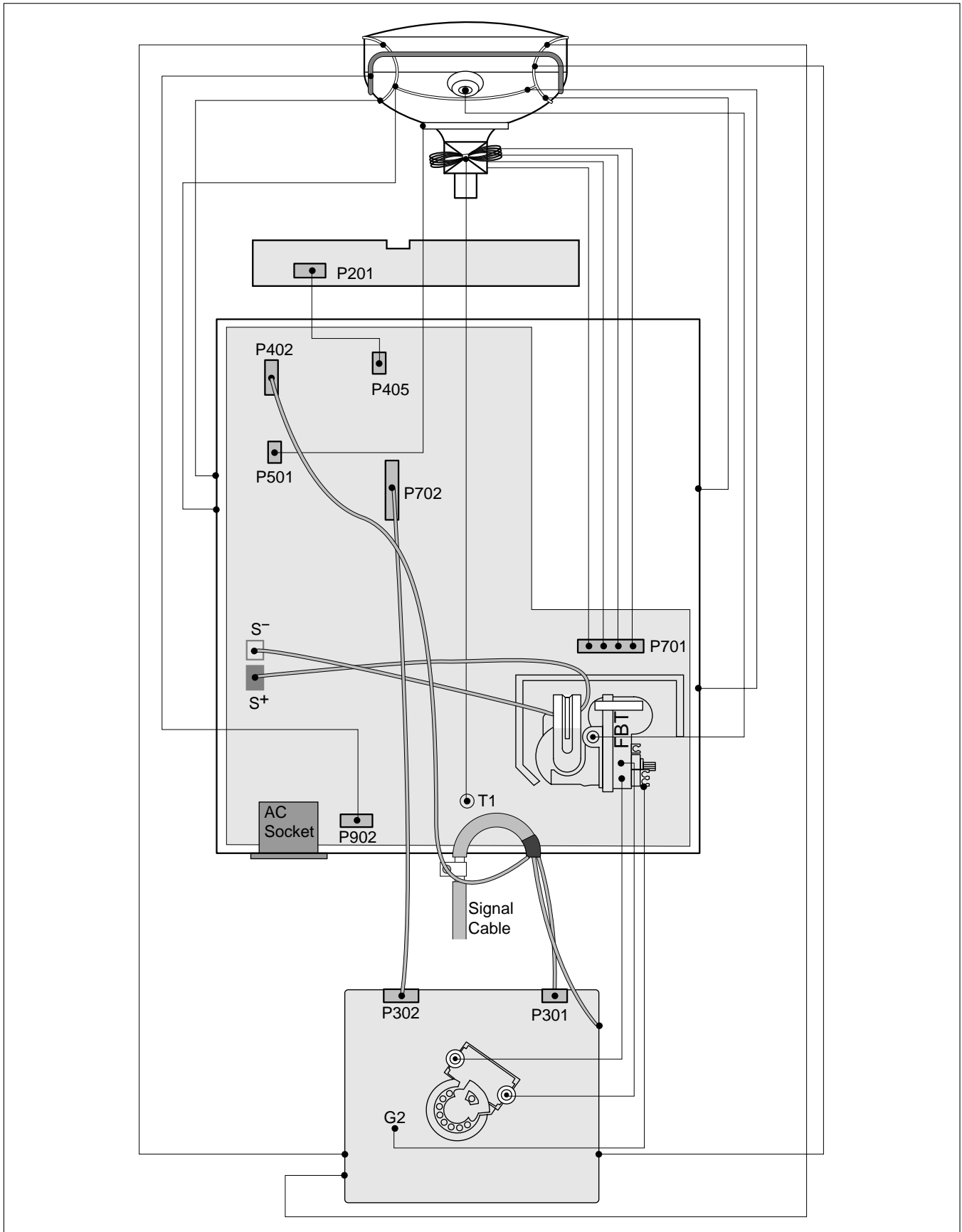

DISASSEMBLY

1. TILT/SWIVEL & BACK COVER REMOVAL

- 1) Set the monitor face downward.
- 2) Pull the latch (a), carefully remove the Tilt/Swivel by pulling it upward.
- 3) Pressing the latch (b), Back cover by pushing it upward.
- 4) Release the latch (c).
- 5) Slide the Back Cover away from the Front Cabinet of the monitor.

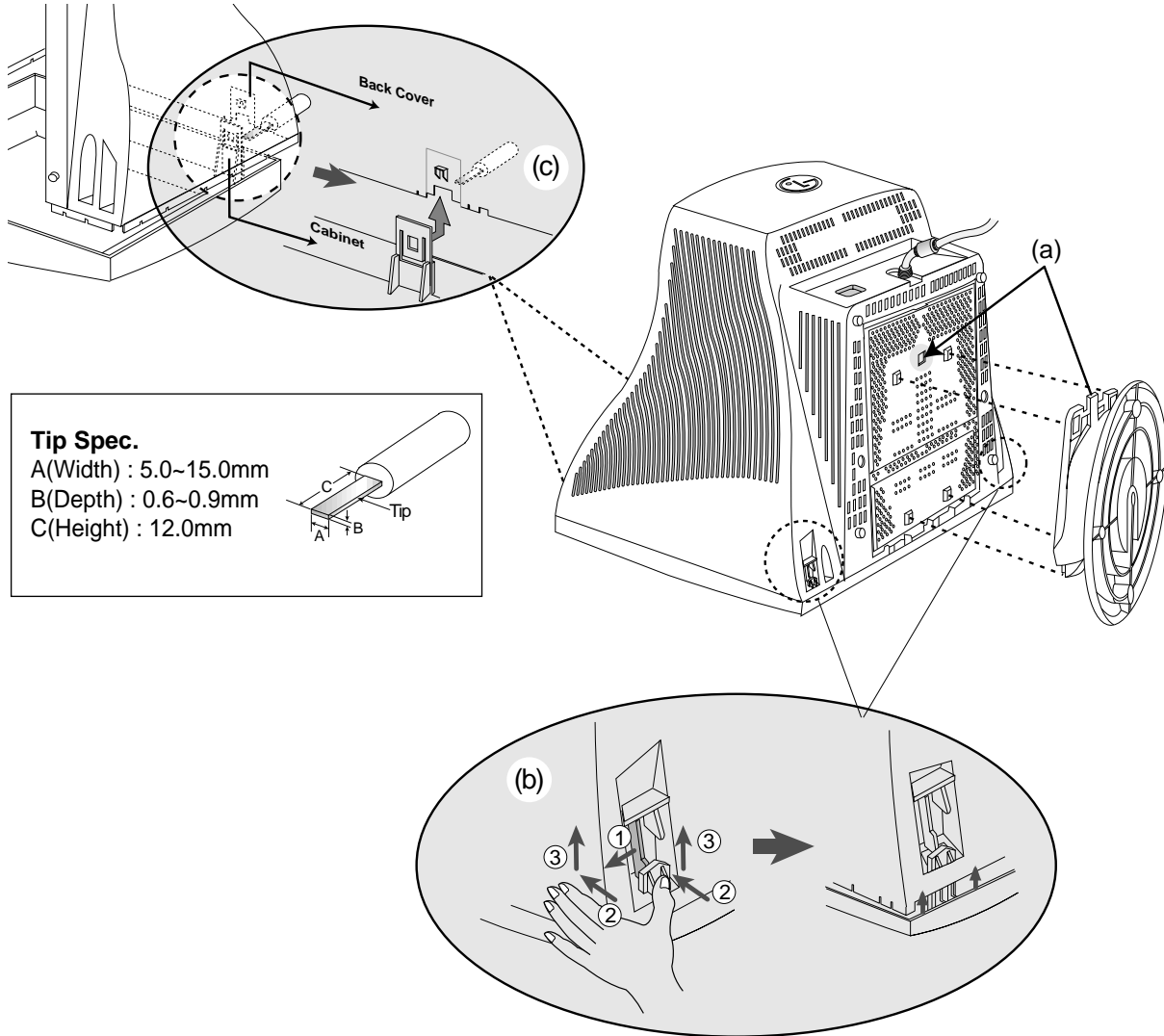

2. TOTAL CHASSIS ASSEMBLY REMOVAL

- 1) Set the monitor face downward.
- 2) Pressing the latch (a), Main Chassis by pushing it upward.

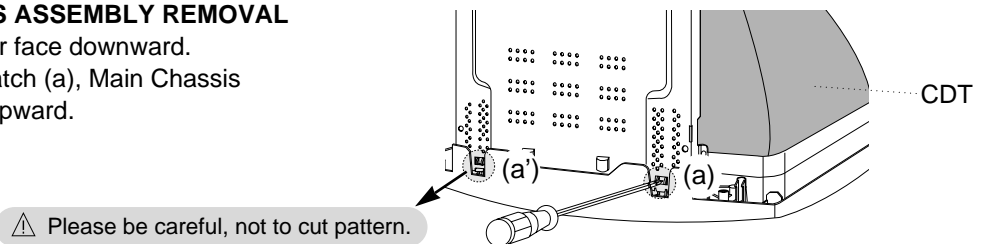

BLOCK DIAGRAM

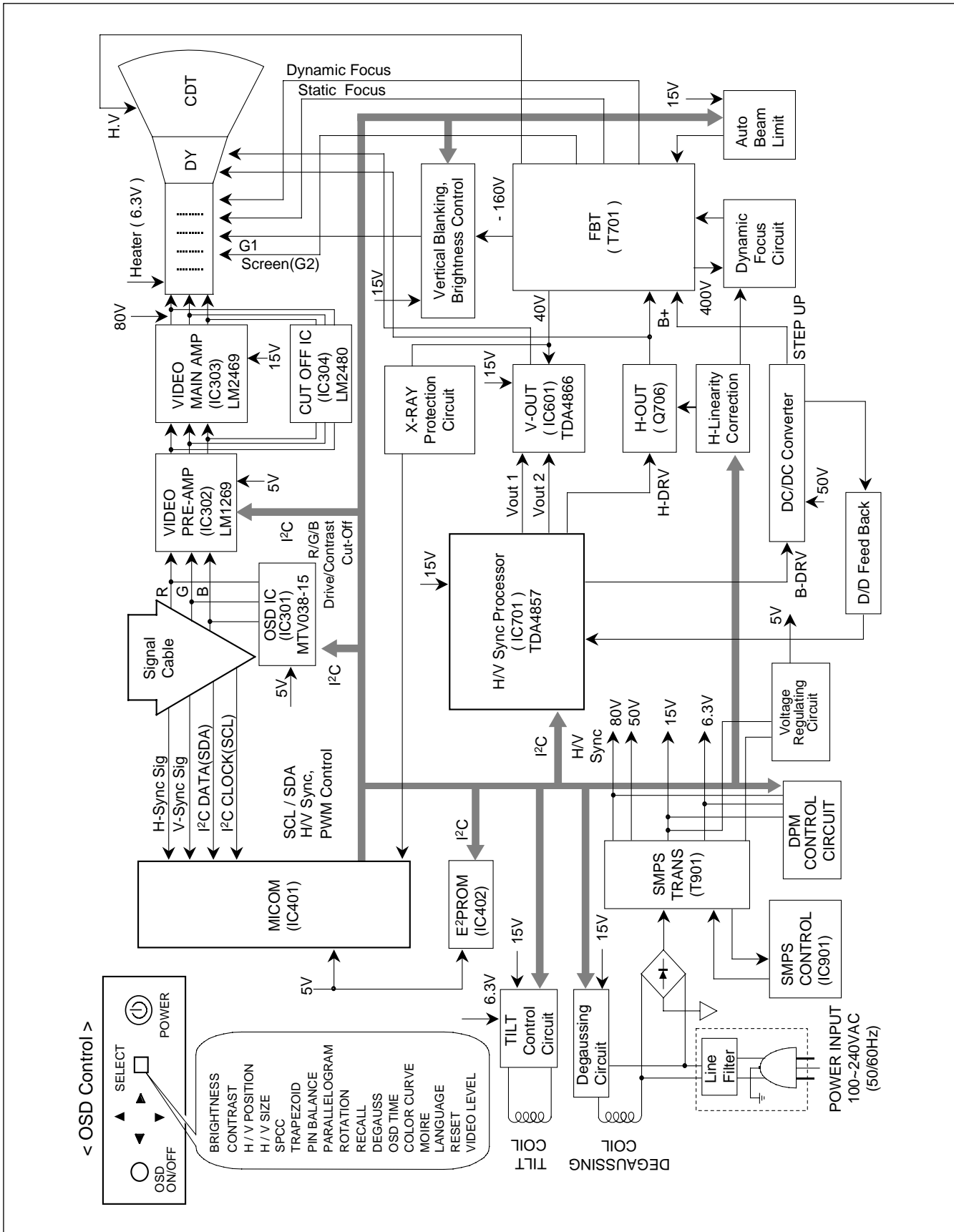

DESCRIPTION OF BLOCK DIAGRAM

1. Line Filter & Associated Circuit.

This is used for suppressing noise of power input line flowing into the monitor and/or some noise generated in this monitor flowing out through the power input line.

That is to say, this circuit prevents interference between the monitor and other electric appliances.

2. Degauss Circuit & Coil.

The degauss circuit consists of the degaussing coil, the PTC(Positive Temperature Coefficient) thermistor(TH901), and the relay(RL901). This circuit eliminates abnormal color of the screen automatically by degaussing the shadow mask in the CRT during turning on the power switch. When you need to degauss in using the monitor, select DEGAUSS on the OSD menu.

3. SMPS(Switching Mode Power Supply).

This circuit is working of 90~264V AC(50/60Hz).

The operation procedure is as follows:

- 1) AC input voltage is rectified and smoothed by the bridge diodes (D900) and the capacitor (C908).
- 2) The rectified voltage(DC) is applied to the primary coil of the transformer(T901).
- 3) The control IC(IC901) generates switching pulse to turn on and off the primary coil of the transformer (T901) repeatedly.
- 4) Depending on turn ratio of the transformer, the secondary voltages appear at the secondary coils of the transformer(T901).
- 5) These secondary voltages are rectified by each diode(D941, D942, D951, D961, D962, D971) and operate other circuit. (horizontal and vertical deflection, video amplifier, ...etc.)

4. X-ray Protection.

If the high voltage of the FBT reaches up to 29kV (abnormal state), IC401(MICOM) pin 35 Sensing from FBT directly.

Then MICOM control IC701 (Deflection controller) to stop Horizontal drive pulse and stop Horizontal Deflection.

5. Micom(Microprocessor) Circuit.

The operating procedure of Micom(Microprocessor) and its associated circuit is as follows:

- 1) H and V sync signal is supplied from the signal cable.
- 2) The Micom(IC401) distinguishes polarity and frequency of H and V sync.
- 3) The Micom sets operating mode and offers the controlled data. (H-size, H-position, V-size, ... etc.)
- 4) The controlled data of each mode is stored in itself.
- 5) User can adjust screen condition by each OSD function. The data of the adjusted condition is stored in EEPROM(IC402).

6. Horizontal and Vertical Oscillation.

This circuit generates the horizontal pulse and the vertical pulse by taking the H and V sync signal.

This circuit consists of the TDA4866(IC601) and the associated circuit.

7. D/D(DC to DC) Converter.

This circuit supplies DC voltage to the horizontal deflection output circuit by increasing DC 50V which is the secondary voltage of the SMPS in accordance with the input horizontal sync signal.

8. Side-Pincushion & Trapezoid Correction Circuit.

This circuit improves the side-pincushion and the trapezoid distortion of the screen by mixing parabola and saw-tooth wave to output of the horizontal deflection D/D converter which is used for the supply voltage(B +) of the deflection circuit.

9. Horizontal Deflection Output Circuit.

This circuit makes the horizontal deflection by supplying the saw-tooth current to the horizontal deflection yoke.

10. High Voltage Output & FBT(Flyback Transformer).

The high voltage output circuit is used for generating pulse to the primary coil of the FBT(Flyback Transformer) secondary of the FBT and it is supplied to the anode, focus, and screen voltage of the CRT.

11. H-Linearity Correction Circuit.

This circuit corrects the horizontal linearity for each horizontal sync frequency.

12. Vertical Output Circuit.

This circuit takes the vertical ramp wave from the TDA4857(IC701) and performs the vertical deflection by supplying the saw-tooth current to the vertical deflection yoke.

13. Dynamic Focus Output Circuit.

This circuit takes the horizontal and the vertical parabola waves from the TDA4857(IC701) and amplifies it to maintain constant focus on center and corners in the screen.

14. H & V Blanking and Brightness Control.

Blanking circuit eliminates retrace line by supplying negative pulse to the G1 of the CRT. And Brightness circuit is used for control of the screen brightness by changing DC level of the G1.

15. Image Rotation (Tilt) Circuit.

This circuit corrects the tilt of the screen by supplying the image rotation signal to the tilt coil which is attached near the deflection yoke of the CRT.

16. Video Pre-Amp Circuit.

This circuit amplifies the analog video signal from 0-0.7V to 0-4V. It is operated by taking the clamp, R, G, B drive and contrast signal from the Micom(IC401).

17. Video Output Amp Circuit.

This circuit amplifies the video signal which comes from the video pre-amp circuit and amplified it to applied the CRT cathode.

ADJUSTMENT

GENERAL INFORMATION

All adjustment are thoroughly checked and corrected when the monitor leaves the factory, but sometimes several adjustments may be required.

Adjustment should be following procedure and after warming up for a minimum of 30 minutes.

- Alignment appliances and tools.
 - IBM compatible PC.
 - Programmable Signal Generator.
(eg. VG-819 made by Astrodesign Co.)
 - EPROM or EEPROM with saved each mode data.
 - Alignment Adaptor and Software.
 - Digital Voltmeter.
 - White Balance Meter.
 - Luminance Meter.
 - High-voltage Meter.

AUTOMATIC AND MANUAL DEGAUSSING

The degaussing coil is mounted around the CDT so that automatic degaussing when turn on the monitor. But a monitor is moved or faced in a different direction, become poor color purity cause of CDT magnetized, then press DEGAUSS on the OSD menu.

ADJUSTMENT PROCEDURE & METHOD

- Install the cable for adjustment such as Figure 1 and run the alignment program on the DOS for IBM compatible PC.
- Set external Brightness and Contrast volume to max position.

1. Adjustment for B⁺ Voltage.

- 1) Display cross hatch pattern at Mode 4.
- 2) Check C961 (+) voltage to 50 ± 0.5 Vdc.

2. Adjustment for High-Voltage.

- 1) Display cross hatch pattern at Mode 4.
- 2) DIST.ADJ. → CTRL PWM → High Voltage Command.
- 3) Adjust High Voltage to $25.5 \text{ kV} \pm 0.1 \text{ kVdc}$.
- 4) Press Enter Key.

3. Adjustment for Factory Mode (Preset Mode).

- 1) Display cross hatch pattern at Mode 1.
- 2) Run alignment program for CB777G on the IBM compatible PC.
- 3) EEPROM → ALL CLEAR → Y(Yes) command.
<Caution> Do not run this procedure unless the EEPROM is changed. All data in EEPROM (mode data and color data) will be erased.
- 4) Power button of the monitor turn off → turn on.
- 5) COMMAND → PRESET START → Y(Yes) command.
- 6) DIST. ADJ. → CTRL PWM → TILT command.

- 7) Adjust tilt as arrow keys to be the best condition.
- 8) DIST. ADJ. → BALANCE command.
- 9) Adjust parallelogram as arrow keys to be the best condition.
- 10) Adjust balance of pin-balance as arrow keys to be the best condition.
- 11) DIST. ADJ. → FOS. ADJ command.
- 12) Adjust V-SIZE as arrow keys to 230 ± 2 mm.
- 13) Adjust V-POSITION as arrow keys to center of the screen.
- 14) Adjust H-SIZE as arrow keys to 310 ± 2 mm.
- 15) Adjust H-POSITION as arrow keys to center of the screen.
- 16) Adjust S-PCC (Side-Pincushion) as arrow keys to be the best condition.
- 17) Adjust TRAPEZOID as arrow keys to be the best condition.
- 18) Save of the Mode 1.
- 19) Display from Mode 2 to 4 and repeat above from number 12) to 19)
- 20) PRESET EXIT → Y (Yes) command.

4. Adjustment for White Balance and Luminance.

- 1) Set the White Balance Meter.
- 2) Press the DEGAUSS on the OSD menu for demagnetization of the CDT.
- 3) COLOR ADJ. → LUMINANCE command of the alignment program.
- 4) Set Brightness and Contrast to Max position.
- 5) Display color 0,0 pattern at Mode 4.
- 6) COLOR ADJ. → BIAS ADJ. → COLOR No. → 1 command of the alignment program.
- 7) Check whether green color or not at R-BIAS and G-BIAS to min position and B-BIAS to 127(7F) and Sub-Brightness to 177(B1) position. Adjust G2 (screen) command to 0.4 ± 0.05 FL of the raster luminance.
- 8) Adjust R-BIAS and G-BIAS command to $x=0.283 \pm 0.005$ and $y=0.298 \pm 0.005$ on the White Balance Meter with PC arrow keys.
- 9) Adjust SUB-Brightness command to 0.4 ± 0.1 FL of the raster luminance.
- 10) Adjust repeat number 8).
- 11) After push the "ENTER" key.
- 11-1) COMMAND → PRESET START → Y(Yes) command.
- 12) Display color 15,0 full white pattern at Mode 4.
- 13) DRIVE ADJ. → No 1. command.

- 14) Set Brightness and Contrast to Max position.
- 15) Set SUB-CONTRAST Max 127(7F) (decimal) position.
- 16) Set B-DRIVE to 100(64) at DRIVE of the alignment program.
- 17-1) Adjust R-DRIVE and G-DRIVE command to white balance $x=0.283\pm0.003$ and $y=0.298\pm0.003$ on the White Balance Meter with PC arrow keys.
- 17-2) Display color 15,0 window pattern (70x70mm) at mode 4.
- 18) Adjust SUB-CONTRAST command to $50\pm2FL$.
- 19) Display color 15,0 full white patten at Mode 4.
- 20) Set Brightness and Contrast to Max position.
- 21) COLOR ADJ. → LUMINANCE → ABL command.
- 22) Adjust ABL to $32\pm1FL$ of the luminance.
- 23) After push the "ENTER" key, and "COMMAND → PRESET EXIT → Y(Yes)" command.
- 24) Exit from the program.

5. Input EDID Data.

- 1) Display color 15,0 cross hatch pattern at Mode 4.
- 2) EEPROM → Write EDID command and confirm "EDID Write OK!!" message of monitor.
- 3) Exit from the alignment program.
- 4) Power switch OFF/ON for EDID data save.

6. Adjustment for Focus.

- 1) Set the Brightness and Contrast to max position.
- 2) Display H character in full screen at Mode 4.
- 3) Adjust two Focus control on the FBT that focus should be the best condition.

TROUBLESHOOTING GUIDE

1. NO POWER

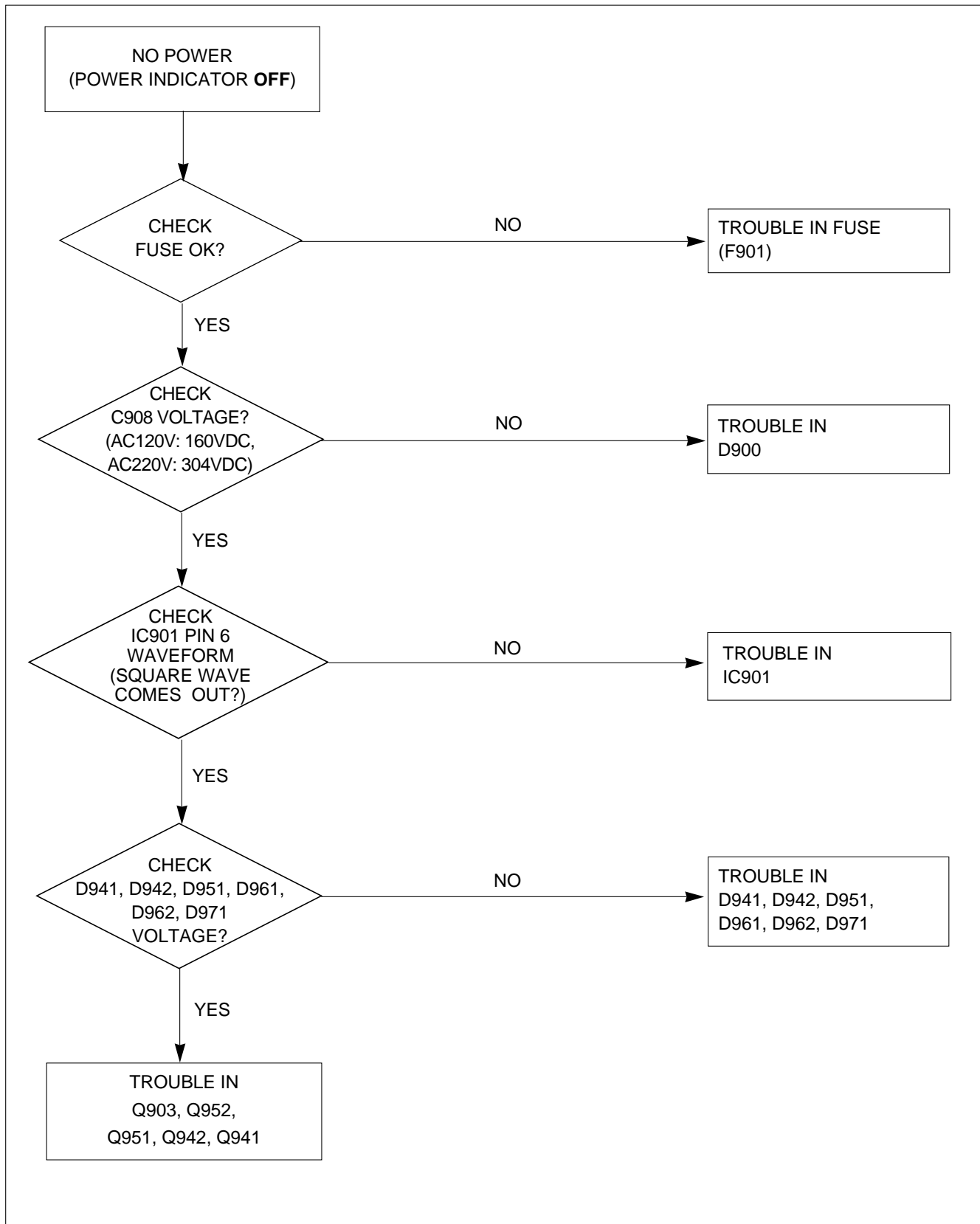

2. NO CHARACTER

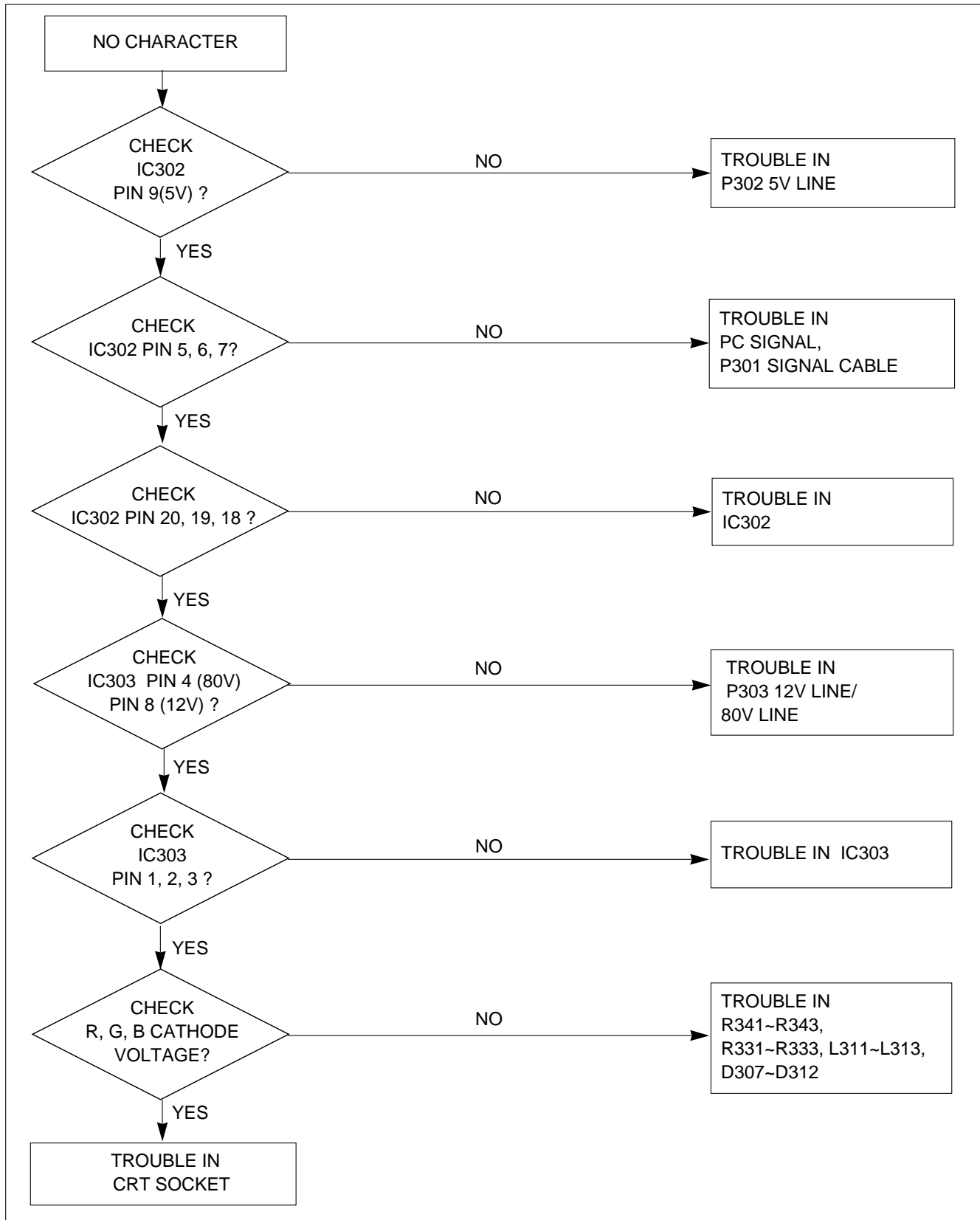

3. NO RASTER

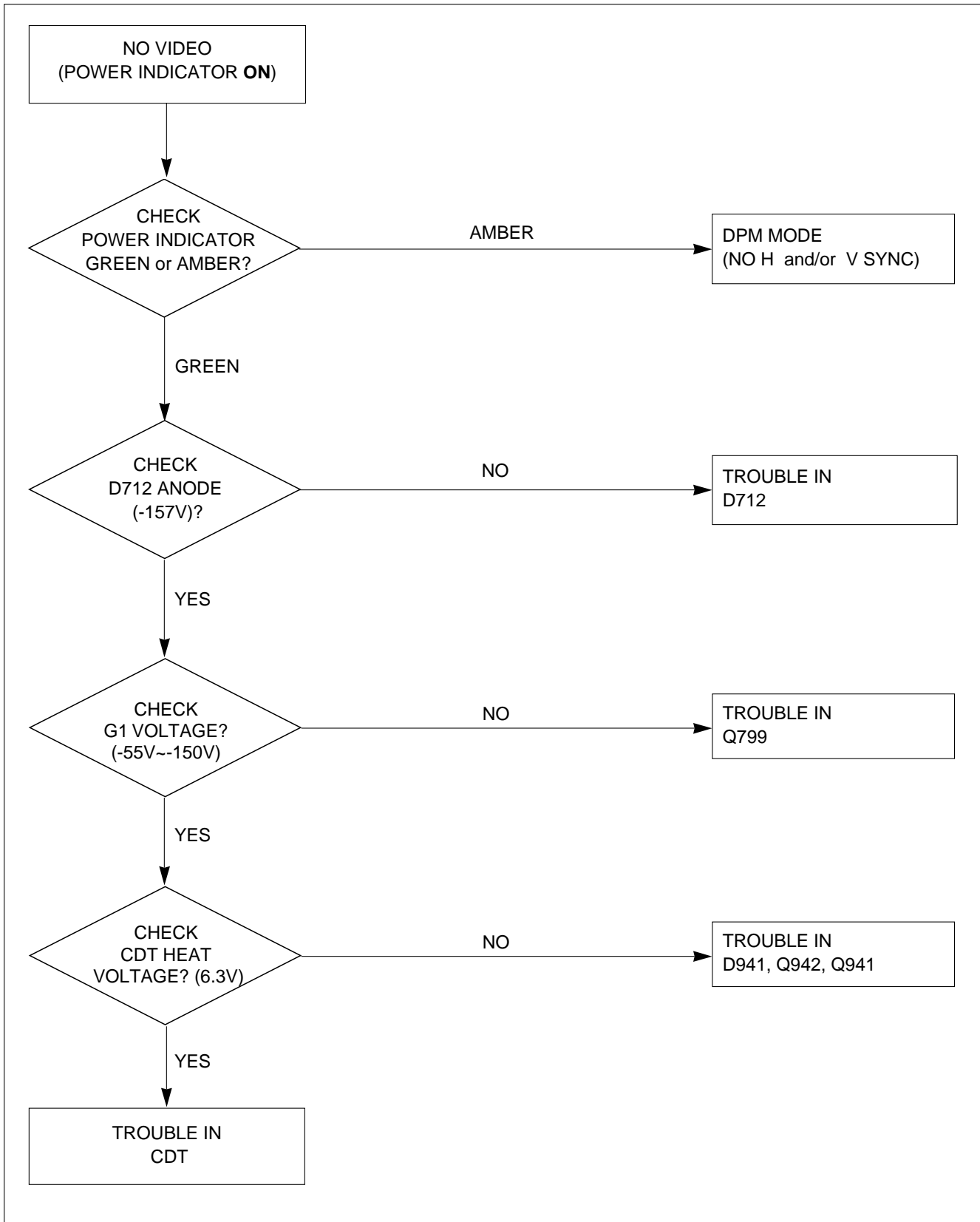

4. NO HORIZONTAL DEFLECTION

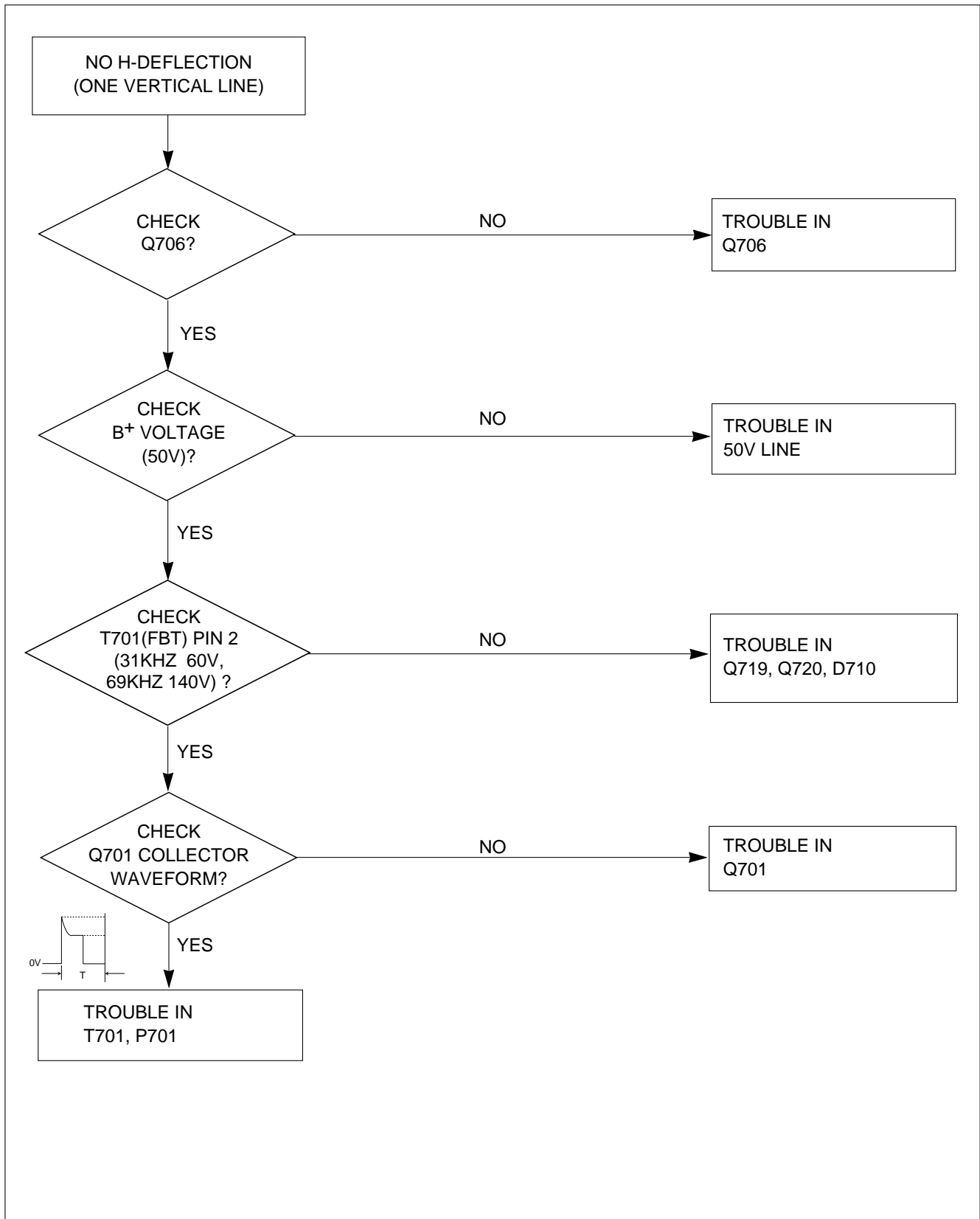

5. TROUBLE IN H-LINEARITY

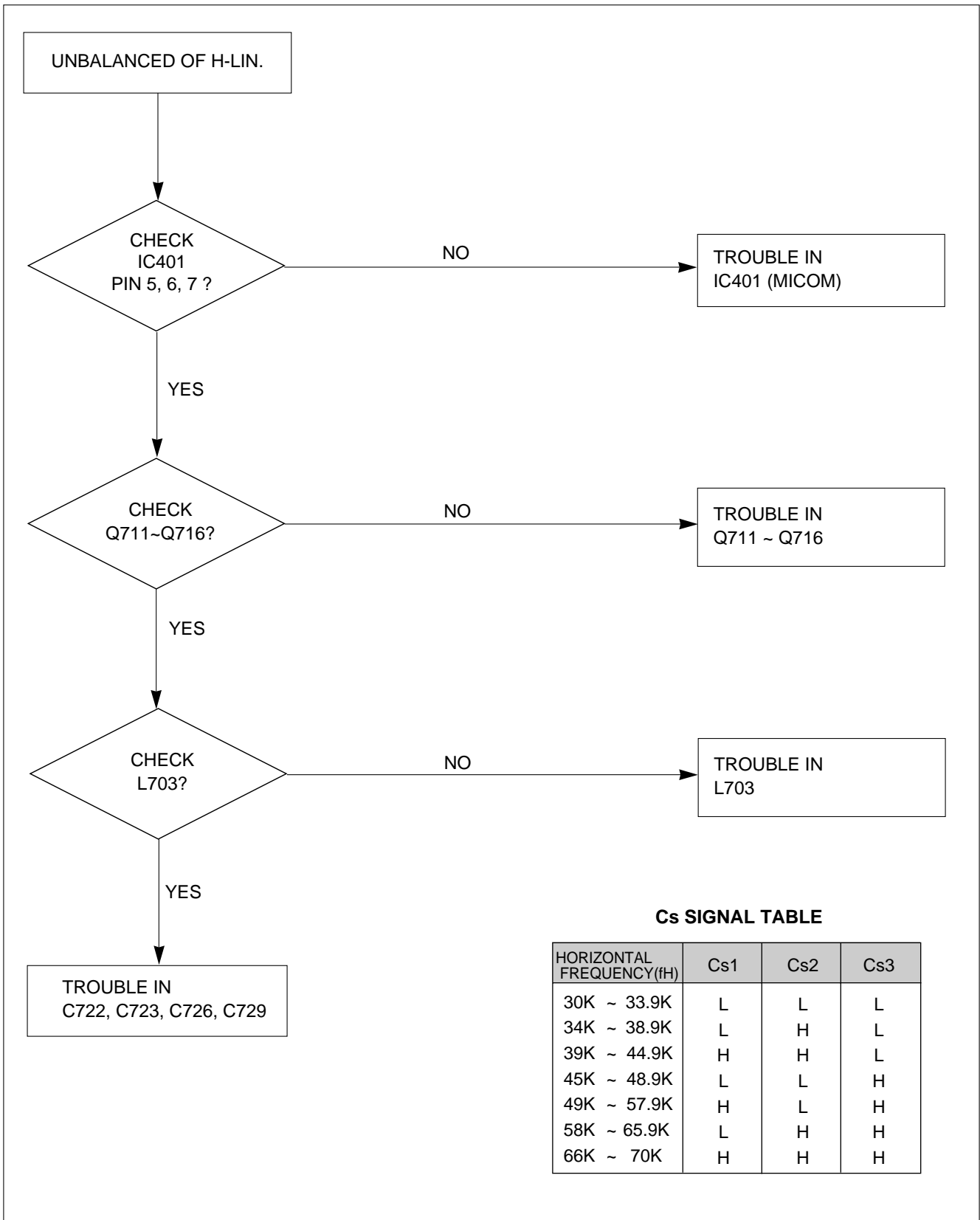

Cs SIGNAL TABLE

HORIZONTAL FREQUENCY(fH)	Cs1	Cs2	Cs3
30K ~ 33.9K	L	L	L
34K ~ 38.9K	L	H	L
39K ~ 44.9K	H	H	L
45K ~ 48.9K	L	L	H
49K ~ 57.9K	H	L	H
58K ~ 65.9K	L	H	H
66K ~ 70K	H	H	H

6. NO VERTICAL DEFLECTION

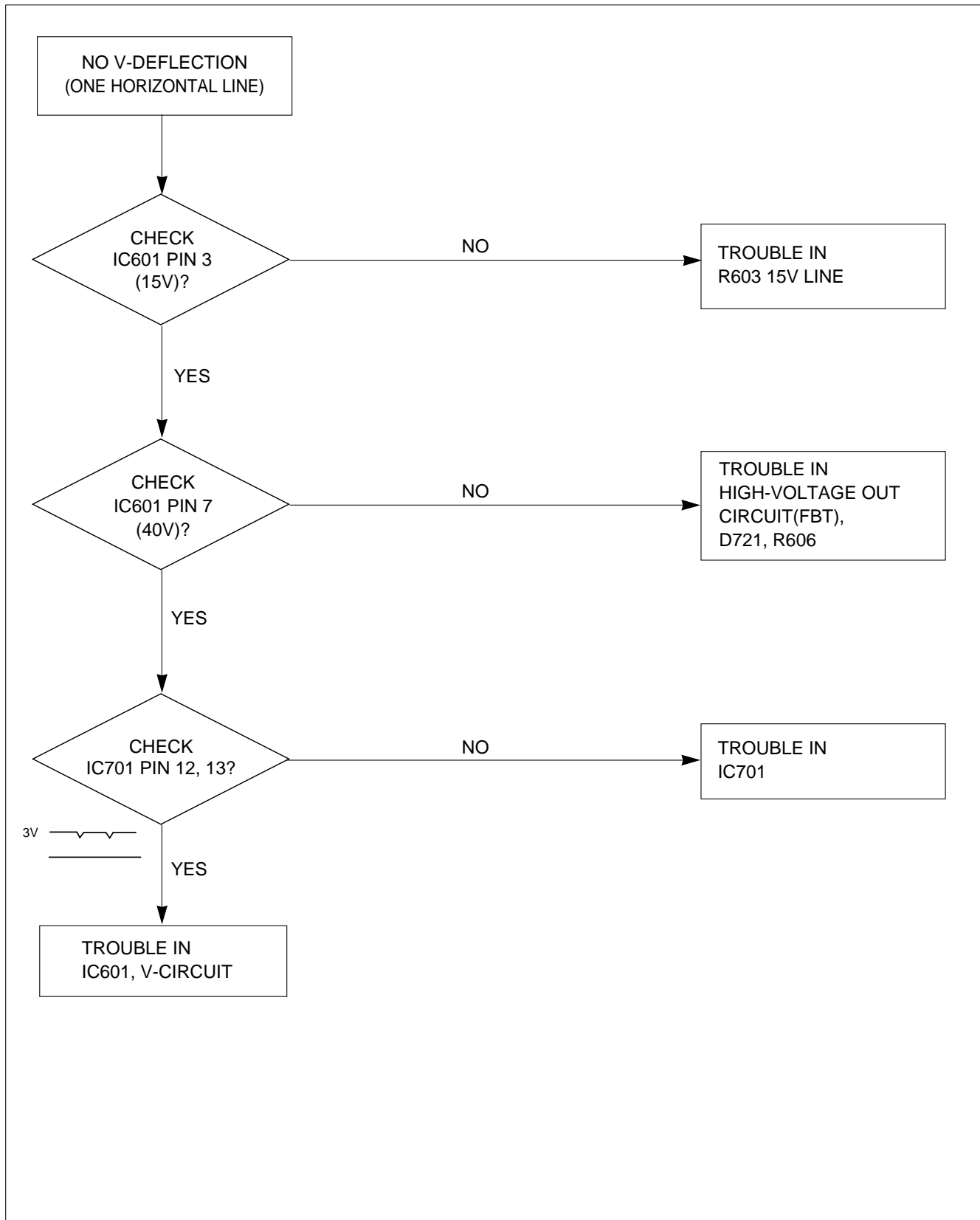

7. TROUBLE IN OSD

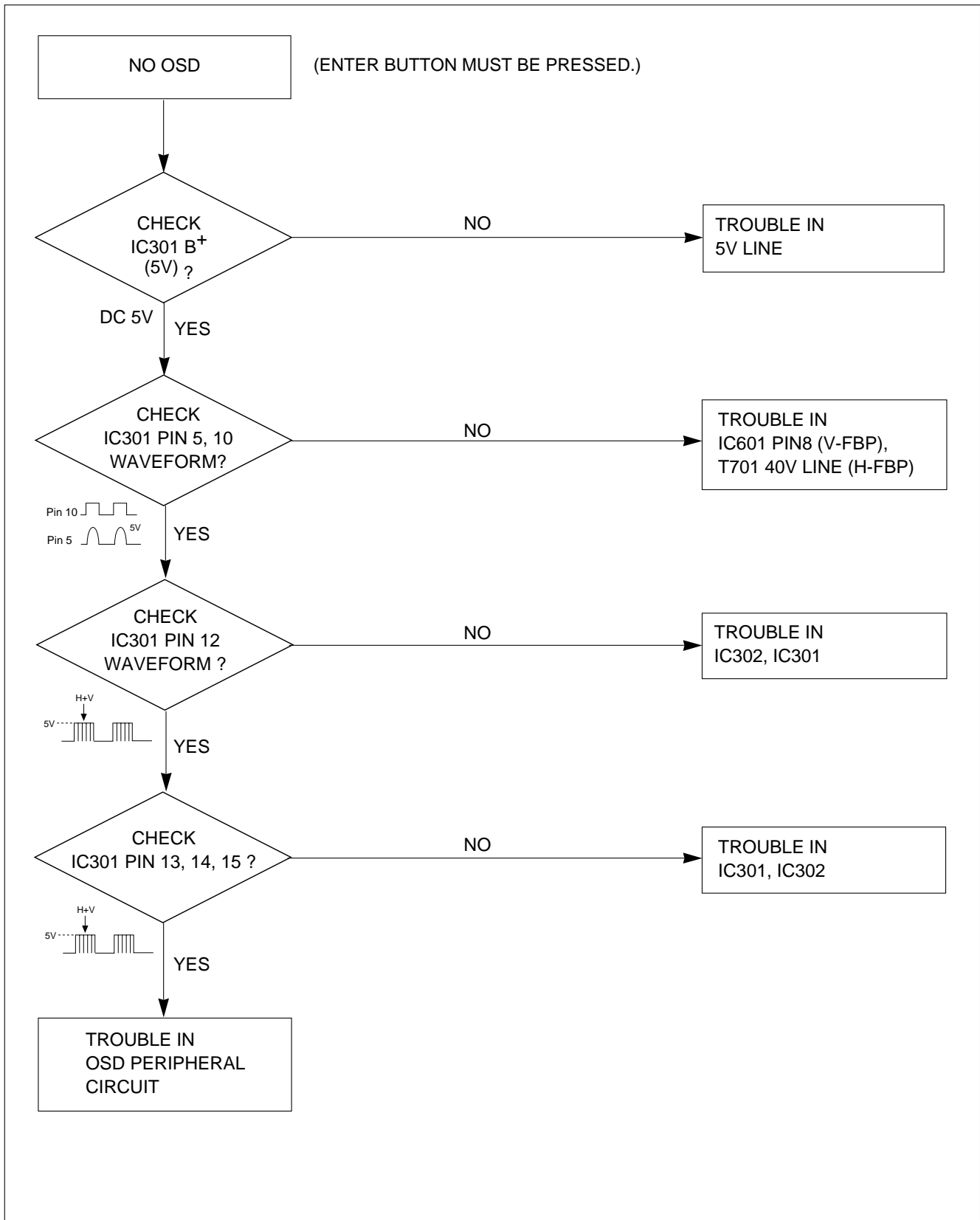

8. TROUBLE IN DPM

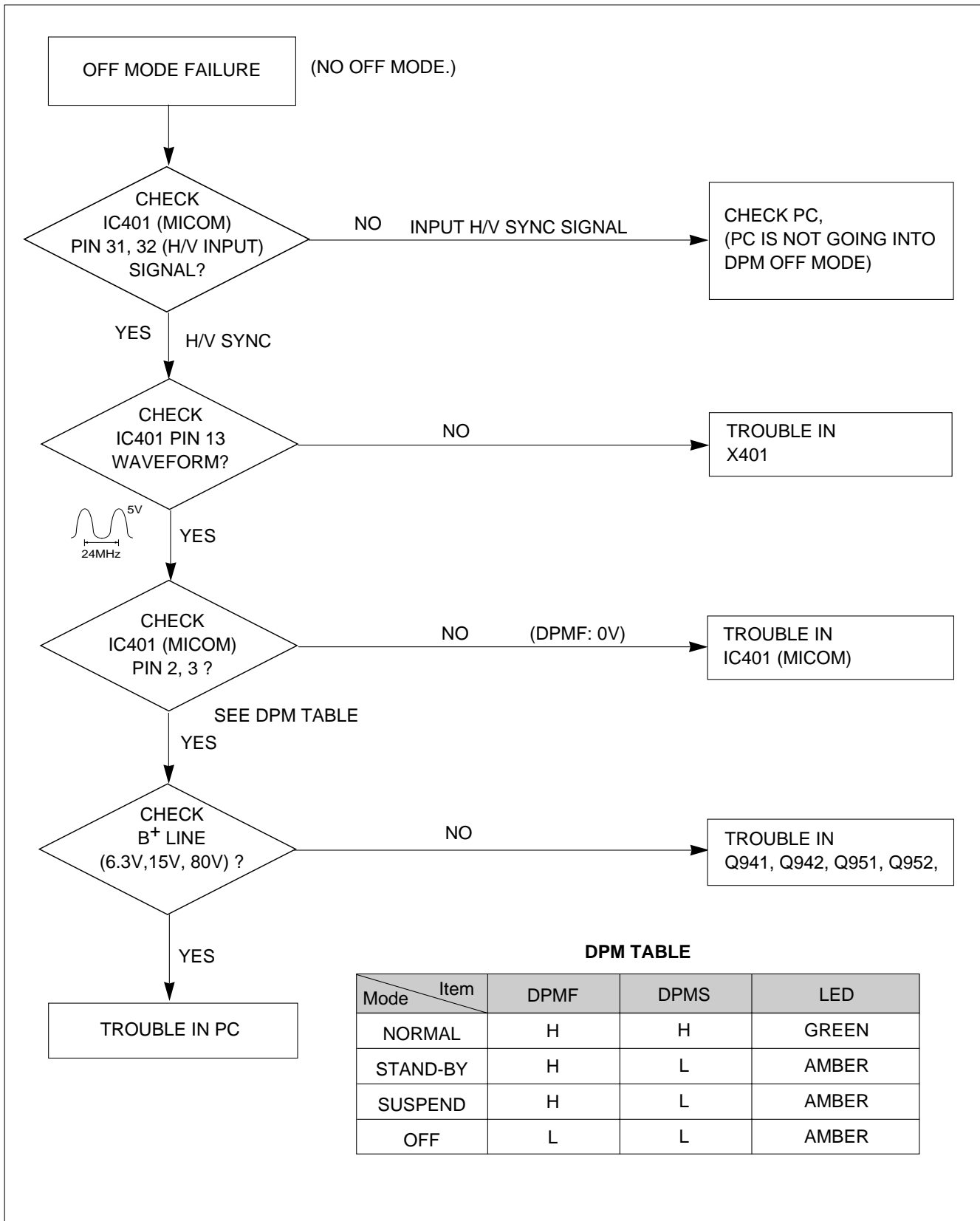

9. NO DEGAUSSING

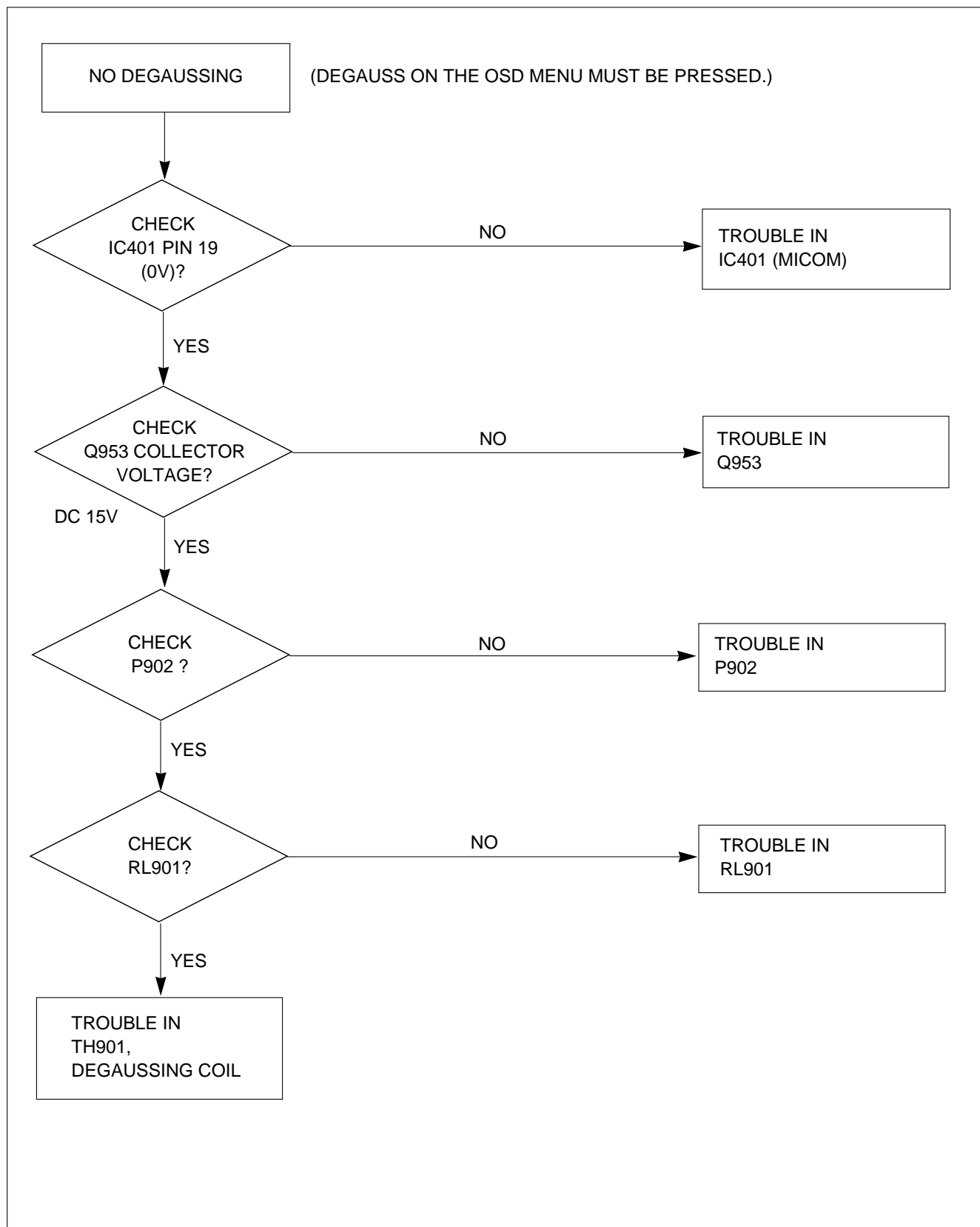

10. NO TILT (NO ROTATION)

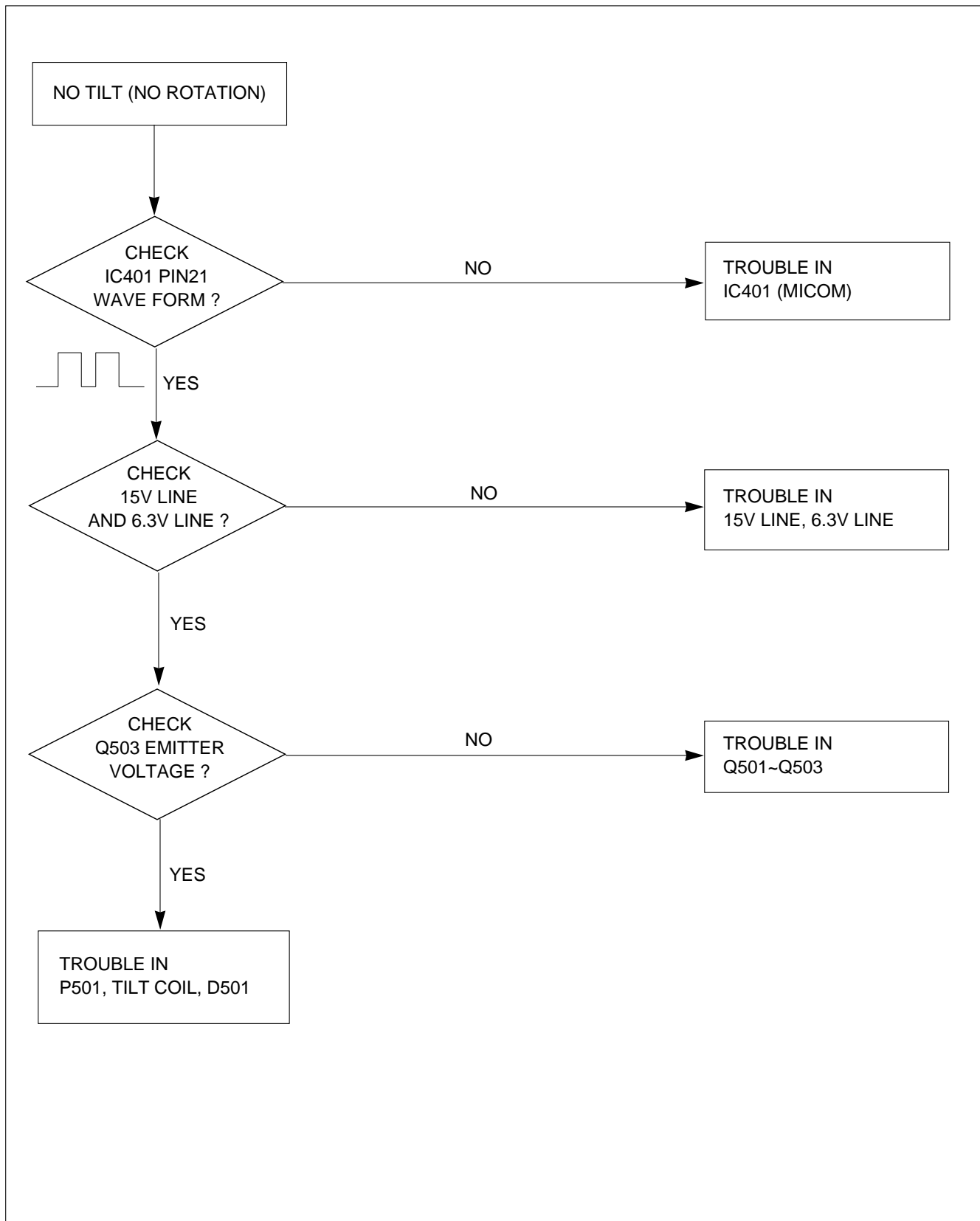

EXPLODED VIEW

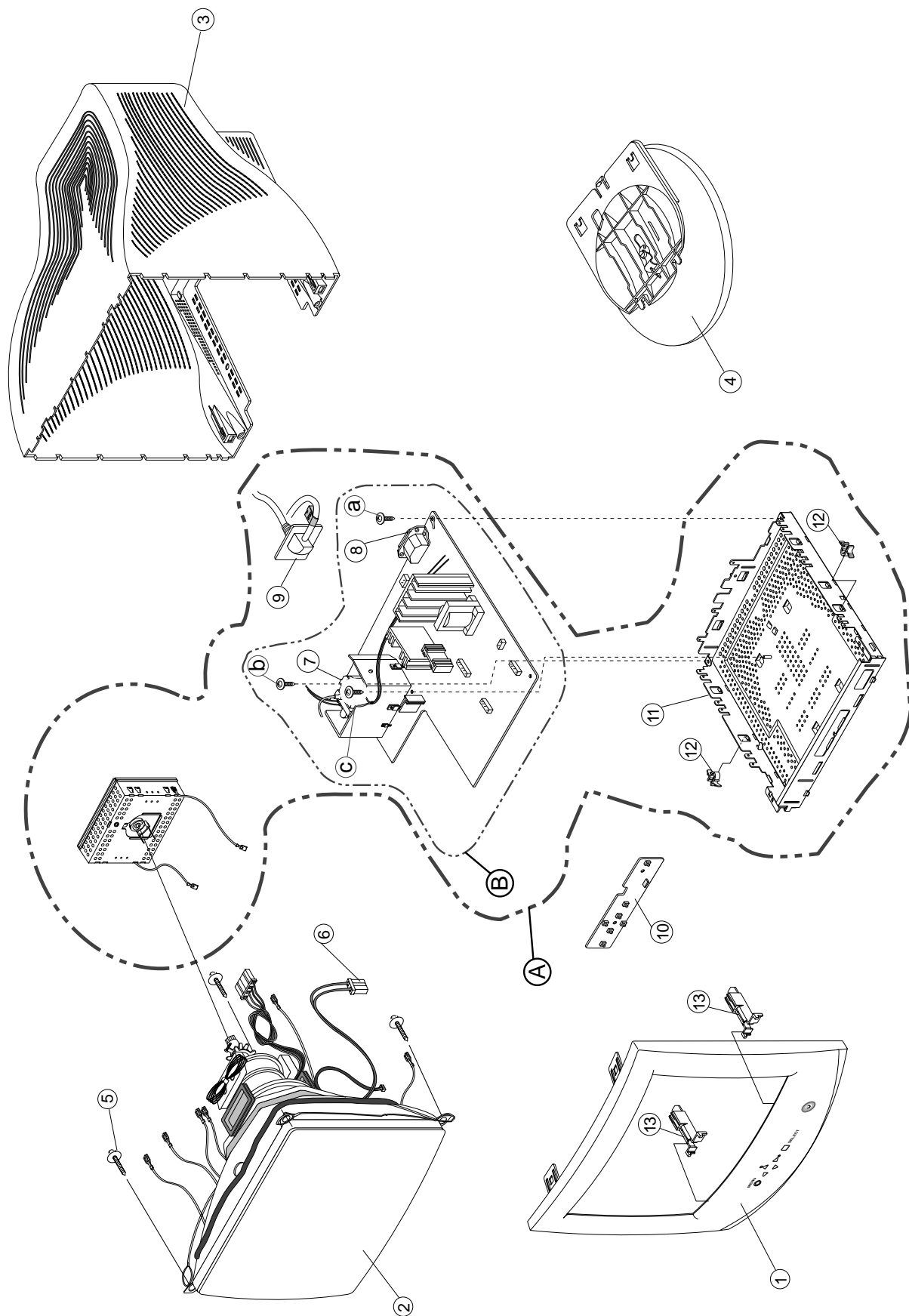

EXPLODED VIEW PARTS LIST

Ref. No.	Part No.	Description
1	3091TKC061G	CABINET ASS'Y, CB777F BRAND C055 "C"CKD,ABS -S/W 700S (CB777G-NA)
	3091TKC061E	CABINET ASS'Y, CB777F BRAND C055 ""A"" CKD -S/W 700B (CB777G-EA)
	3091TKC061L	CABINET ASS'Y, CB777F BRAND C055 MPR,SW700E,LG(RE D) -S/W 700E (CB777G-AA)
	3091TKC061C	CABINET ASS'Y, CB777F BRAND C055 ABS -For China, India: S/W 700S (CB777G-NA)
	3091TKC061J	CABINET ASS'Y, CB777F BRAND C055, MPR2/LG(RE D) -For Brazil: S/W 700S(CB777G-NA)
2	2423GC0B89Z	CDT SET, M41LFQ803X 46NLAA -For Northern Hemisphere: S/W 700S(CB777G-NA), S/W 700B(CB777G-EA; Russia)
	2423GC5E93A	CDT(CIRC), M41LFQ903X 72NLLD LG-PHILIPS Displays 70KHZ 29.1 mm -For Northern Hemisphere:S/W 700B(CB777G-EA)
	2423GC5E91D	CDT(CIRC), M41LFQ913X 46NLLD LG-PHILIPS Displays 70KHZ 29.1 mm -For Israel:S/W 700B(CB777G-EA)
	2423GC5E81G	CDT(CIRC), M41LFQ803X 49RLLD LG-PHILIPS Displays 70KHZ 29.1 mm -For Equatorial:S/W 700E(CB777G-AA)
	2423GC0B88H	CDT SET, M41LFQ803X 46RLAA -For Equatorial:S/W 700S (CB777G-NA)
2423GC0B88G	CDT SET, M41LFQ803X 46SLAA -For Southern Hemisphere:S/W 700S (CB777G-NA)	
3	3809TKC035B	BACK COVER ASS'Y, CB777F C035 ABS -S/W 700S(CB777G-NA), S/W 700E(CB777G-AA)
	3809TKC035A	BACK COVER ASS'Y, CB777F C035 PC-ABS 4TH -S/W 700B(CB777G-EA)
4	3043TKK074B	TILT SWIVEL ASS'Y, CB777F B046/T053 LOCAL,RUBBER CKD -S/W 700S(CB777G-NA)
	3043TKK074A	TILT SWIVEL ASSEMBLY, CB777F T053/B046 4TH-HIPS -For Europe, U.K, Russia:(CB777G-EA), For Panama:(CB777G-AA), For India:(CB777G-NA)
	3043TKK063B	TILT SWIVEL ASSEMBLY, KCB777D . 60HR(85964)NT LOCAL -For China:(CB777G-NA)
5	339-002H	SCREW ASS'Y, PHP+5*20(FZMY)+GW18 NEW TYPE
6	6140TC3004A	COIL,DEGAUSSING, 1090MM 16.5OHM 0.4MM 110T 17" WITH EARTH -S/W 700S(CB777G-NA), S/W 700B(CB777G-EA), S/W 700E(CB777G-AA)
	6140TC3004D	COIL,DEGAUSSING, LX31 GET 0.4*110TS,1090MM,16.5 OHM,W/O EARTH" -For China:S/W 700S(CB777G-NA)
7	6174T11003E	FBT (FLY BACK TRANSFORMER), 1054A,CB777G LG-PHILIPS 17"
8	6620TKB002B	SOCKET(CIRC),POWER, SA-4S HUA JIE AC UNIVERSAL 3PIN BLACK
9	6850TA9004A	CABLE, D-SUB, UL 2990-9C(7.5) AT 1560MM GLAY CB777G DM
10	6871TST284C	PWB(PCB) ASSEMBLY, SUB, CB777G CONTROL TOTAL BRAND LGEDI -S/W 700S(CB777G-NA), for Israel: S/W 700B (CB777G-EA)
	6871TST284B	PWB(PCB) ASSEMBLY, SUB, CB777G CONTROL TOTAL BRAND CA-109 -S/W 700B(CB777G-EA), S/W 700E(CB777G-AA)
	6871TST284D	PWB(PCB) ASSEMBLY, SUB, CB777G CONTROL TOTAL BRAND CA-109 -For China:S/W 700S(CB777G-NA)
	6871TST284F	PWB(PCB) ASSEMBLY, SUB, CB777G.KQLBMS CONTROL TOTAL BRAND CA-112 -For Brazil: S/W 700S(CB777G-NA)
	6871TST284E	PWB(PCB) ASSEMBLY, SUB, CB777G CONTROL TOTAL BRAND KQIDML-For India: S/W 700S(CB777G-NA)
11	4950TKS169B	METAL, SHIELD BOTTOM(A-CKD)
12	4930TKK031C	HOLDER, PCB FIX , PC+ABS
13	4810TKK171A	BRACKET, CB777F SUPPORTER CDT
A	3313T17254C	MAIN TOTAL ASSEMBLY, CB777G.KXLVMD BRAND CA-109 -S/W 700S(CB777G-NA)
	3313T17254B	MAIN TOTAL ASSEMBLY, CB777G BRAND CA-109 -For Europe, U.K, Russia:S/W 700B(CB777G-EA)
	3313T17254H	MAIN TOTAL ASSEMBLY, CB777G.KXIRED BRAND CA-109 -For Israel:S/W 700B(CB777G-EA)
	3313T17254E	MAIN TOTAL ASSEMBLY, CB777G BRAND CA-109 -For Panama:S/W 700E(CB777G-AA)
	3313T17254D	MAIN TOTAL ASSEMBLY, CB777G.KXLCMT BRAND CA-109 -For China:S/W 700S(CB777G-NA)
	3313T17254L	MAIN TOTAL ASSEMBLY, CB777G.KHLAMD BRAND CA-109 -For Australia, S.Africa:S/W 700S(CB777G-NA)
	3313T17254J	MAIN TOTAL ASSEMBLY, CB777G.KQLBMS BRAND CA-109 -For Brazil:S/W 700S(CB777G-NA)
3313T17254G	MAIN TOTAL ASSEMBLY, CB777G.KQIDML BRAND CA-109 -For India:S/W 700S(CB777G-NA)	
B	6871TMT288C	PWB(PCB) ASSEMBLY, MAIN, CB777G KXLVMD BRAND CA-109 TOTAL -S/W 700S(CB777G-NA)
	6871TMT288B	PWB(PCB) ASSEMBLY, MAIN, CB777G KCLVEA BRAND CA-109 TOTAL -For Europe,U.K, Russia:S/W 700B(CB777G-EA), For Panama:S/W 700E(CB777G-AA)
	6871TMT288F	PWB(PCB) ASSEMBLY, MAIN, CB777G KXIRED BRAND CA-109 TOTA -For Israel:S/W 700B(CB777G-EA)
	6871TMT288D	PWB(PCB) ASSEMBLY, MAIN, CB777G KXLCMT BRAND CA-109 TOTAL -For China:S/W 700S(CB777G-NA)
	6871TMT288J	PWB(PCB) ASSEMBLY, MAIN, CB777G KHLAMD BRAND CA-109 TOTAL -For Australia, S.Africa:S/W 700S(CB777G-NA)
	6871TMT288G	PWB(PCB) ASSEMBLY, MAIN, CB777G KQLBMS BRAND CA-109 TOTAL -For Brazil:S/W 700S(CB777G-NA)
6871TMT288E	PWB(PCB) ASSEMBLY, MAIN, CB777G KQIDML BRAND CA-109 TOTAL -For India:S/W 700S(CB777G-NA)	
a	332-112F	SCREW, DRAWING, D3.5 L10.0 MSWR/FZMY+SW3.5+RW3.5
b	4001TKK004E	SCREW ASSEMBLY, TAPTITE P TYPE D3.0 L10.0 MSWR/FZMY SW3+RW10
c	339-008C	SCREW ASSY, MP+3*10(FZMY) + SW3+RW3

REPLACEMENT PARTS LIST

CAUTION: BEFORE REPLACING ANY OF THESE COMPONENTS,
READ CAREFULLY THE **SAFETY PRECAUTIONS** IN THIS MANUAL.

* NOTE : **S** SAFETY Mark
AL ALTERNATIVE PARTS

DATE: 2002. 01. 23.				
*S	*AL	LOC. NO.	PART NO.	DESCRIPTION / SPECIFICATION
CAPACITORS				
			C201	0CN1040K949 0.1M 50V Z F TA52
			C301	181-288N MKT 100V 103JTR PHS86103
			C302	0CE107CF638 "100UF SHL,SD 16V M FM5 TP 5"
			C303	0CK1040K945 0.1UF 50V Z F TR
			C304	0CK1030K945 0.01UF 50V Z F TR
			C305	0CE107CF638 "100UF SHL,SD 16V M FM5 TP 5"
			C306	181-288N MKT 100V 103JTR PHS86103
			C307	0CK3910K515 390P 50V K B TS
			C308	0CN1040K949 0.1M 50V Z F TA52
			C309	0CK1040K945 0.1UF 50V Z F TR
			C310	181-288B MKT 100V 104JTR PHS26104
			C311	0CK1040K945 0.1UF 50V Z F TR
			C312	0CN1040K949 0.1M 50V Z F TA52
			C313	0CK1040K945 0.1UF 50V Z F TR
			C314	0CC4700W405 47PF 500V J SL TP
			C315	0CE476CF638 "47UF SHL,SD 16V M FM5 TP 5"
			C316	0CK1010W515 100P 500V K B TS
			C317	0CN1040K949 0.1M 50V Z F TA52
			C318	0CK1040K945 0.1UF 50V Z F TR
			C319	0CN1040K949 0.1M 50V Z F TA52
			C320	0CK1040K945 0.1UF 50V Z F TR
			C321	0CE475CK638 "4.7UF SHL,SD 50V M FM5 TP 5"
			C322	0CN6810K519 680P 50V K B TA52
			C323	0CE476CF638 "47UF SHL,SD 16V M FM5 TP 5"
			C324	0CK1040K945 0.1UF 50V Z F TR
			C325	181-288B MKT 100V 104JTR PHS26104
			C326	0CE106CN638 "10UF SHL,SD 100V M FM5 TP 5"
			C327	181-288B MKT 100V 104JTR PHS26104
			C328	0CE106CN638 "10UF SHL,SD 100V M FM5 TP 5"
			C329	181-288B MKT 100V 104JTR PHS26104
			C330	181-288B MKT 100V 104JTR PHS26104
			C331	181-288G MKT 100V 334JTR PHS26334
			C332	181-288G MKT 100V 334JTR PHS26334
			C333	181-288G MKT 100V 334JTR PHS26334
			C334	181-288B MKT 100V 104JTR PHS26104
			C335	181-288B MKT 100V 104JTR PHS26104
			C336	181-288E MKT 100V 474JTR PHS 26474
			C339	0CK4710W515 470P 500V K B TS
			C340	0CK1040K945 0.1UF 50V Z F TR
			C341	0CK10302940 0.01M 2KV Z F S
			C342	0CE106CK638 "10UF SHL,SD 50V M FM5 TP 5"
			C346	0CK10202515 1000PF D 2KV 10% TR B(Y5P)
			C354	0CC0400K115 4P 50V D NP0 TS
			C355	0CC0400K115 4P 50V D NP0 TS
			C356	0CC0400K115 4P 50V D NP0 TS
			C358	0CK8210K515 820P 50V K B TS
			C372	0CK1040K945 0.1UF 50V Z F TR
			C401	0CN1040K949 0.1M 50V Z F TA52
			C402	0CE476CF638 "47UF SHL,SD 16V M FM5 TP 5"
			C403	0CK1040K945 0.1UF 50V Z F TR
			C404	0CC1800K415 18P 50V J NPO TP
			C405	0CC1800K415 18P 50V J NPO TP
			C406	0CK1010K515 100PF 50V K B TR

DATE: 2002. 01. 23.				
*S	*AL	LOC. NO.	PART NO.	DESCRIPTION / SPECIFICATION
			C407	0CK1010K515 100PF 50V K B TR
			C408	0CK1040K945 0.1UF 50V Z F TR
			C409	0CC5600K415 56P 50V J NP0 TP
			C410	0CK1010K515 100PF 50V K B TR
			C411	0CK1040K945 0.1UF 50V Z F TR
			C412	0CK1040K945 0.1UF 50V Z F TR
			C413	0CK1040K945 0.1UF 50V Z F TR
			C501	0CE106CF638 "10UF SHL,SD 16V M FM5 TP 5"
			C599	0CE225CK638 "2.2UF SHL,SD 50V M FM5 TP 5"
			C601	0CE477EH618 470UF KMG 25V M FL TP 5
			C602	181-288B MKT 100V 104JTR PHS26104
			C603	0CE476CK638 "47UF SHL,SD 50V M FM5 TP 5"
			C604	181-288T MKT 100V 223KTR PHS85223
			C605	0CK1020W515 1000P 500V K B TS
			C701	0CQ5621N419 5600P 100V J POLY NI TP
			C702	0CZZTFT001M ECQB1H103JM3 103J 50V TP5.0
			C703	0CZZTFT001Z ECQB1H104JM3 104J 50V TP5.0
			C704	0CQ8221N519 0.0082U 100V K POLY NI TP
			C705	0CE476CF638 "47UF SHL,SD 16V M FM5 TP 5"
			C706	0CZZTFT001Z ECQB1H104JM3 104J 50V TP5.0
			C707	0CZZTFT002B ECQV1H154JZ3 154J 50V TP5.0
			C708	0CE227CH638 "220UF SHL,SD 25V M FM5 TP 5"
			C709	181-288P MKT 100V 153JTR PHS86153
			C711	0CQ5621N419 5600P 100V J POLY NI TP
			C713	0CQ1031N419 0.01U 100V J POLY NI TP
			C716	0CK2710K515 270P 50V K B TS
			C717	0CE105CN638 "1UF SHL,SD 100V M FM5 TP 5"
			C718	181-288D MKT 100V 473JTR PHS26473
			C719	0CZZTAB001A SM-BP(P)/BP 10UF 50V 13*25
			C720	0CK22101515 220P 1KV K B TP5
			C721	181-477L 682J 19.5*12.0*7.0*7.5 250V
			C722	181-303R 304J 31.0*21.0*13.0*20.0 25
			C723	181-305C 154J 19.0*14.0*8.0*10.0 250
			C724	0CN1040K949 0.1M 50V Z F TA52
			C726	181-482J 394J 18.0*19.0*12.0*7.5 250
			C727	0CN1040K949 0.1M 50V Z F TA52
			C728	0CQ5621N419 5600P 100V J POLY NI TP
			C729	181-305L 684J 26.0*19.0*12.5*15.0 25
			C730	0CN1040K949 0.1M 50V Z F TA52
	△		C731	0CBZTBU004H 5600PF D 2.5KV H M/PP NI FM
			C732	0CQ1031N419 0.01U 100V J POLY NI TP
			C733	0CBZTBU003H 362J 20.0*12.0*7.0*10.0 800
			C737	0CK10102515 100PF 2KV K B TR
			C739	0CE226CK638 "22UF SHL,SD 50V M FM5 TP 5"
			C740	0CE227EL630 220UF KMG 63V M FM5 BULK
			C741	0CZZTFT002B ECQV1H154JZ3 154J 50V TP5.0
			C742	0CZZTFT001R ECQB1H223JM3 223J 50V TP5.0
			C743	0CK3310W515 330P 500V K B TS
			C744	0CE107CP630 100UF SHL 160V M FM5 BULK
			C745	0CK5610W515 560P 500V K B TS
			C746	0CK33101515 330P 1KV K B TS
			C747	0CK3320W515 3300P 500V K B TS
			C748	0CZZTFT002B ECQV1H154JZ3 154J 50V TP5.0
			C749	0CE2256R638 2.2000UF SMS 250V M FM5 TP5

DATE: 2002. 01. 23.				
*S	*AL	LOC. NO.	PART NO.	DESCRIPTION / SPECIFICATION
		C750	OCK1040K945	0.1UF 50V Z F TR
		C751	181-288N	MKT 100V 103JTR PHS86103
		C752	0CQ4721N419	0.0047U 100V J POLY NI TP5
		C754	0CC4700W405	47PF 500V J SL TP
		C755	OCK1040K945	0.1UF 50V Z F TR
		C767	OCK10301510	0.01M 1KV K B S
		C771	OCK10301510	0.01M 1KV K B S
		C773	0CE107CH638	"100UF SHL,SD 25V M FM5 TP 5"
		C774	181-288B	MKT 100V 104JTR PHS26104
		C775	OCK2210K515	220P 50V K B TS
		C781	OCK1030K945	0.01UF 50V Z F TR
		C801	OCK1040K945	0.1UF 50V Z F TR
		C802	0CE106CK638	"10UF SHL,SD 50V M FM5 TP 5"
		C805	0CE106CK638	"10UF SHL,SD 50V M FM5 TP 5"
		C810	0CE106CK638	"10UF SHL,SD 50V M FM5 TP 5"
		C901	0CBZTBU002B	BULK PCX2 335 474K
		C902	0CBZTBU002A	BULK PCX2 335 224K
		C903	OCKZTTA003A	SC E 222M 10.0FF7 250V TP7.
		C904	OCKZTTA003A	SC E 222M 10.0FF7 250V TP7.
		C905	0CE476EK638	47UF KMG 50V M FM5 TP 5
		C906	OCK1520K515	1500P 50V K B TS
		C908	181-124R	220UF SMG(25.4*40) 400V M V
		C909	181-304T	273J 19.5*14.0*8.5*10.0 400
		C910	OCK33101515	330P 1KV K B TS
		C911	0CQ1021N419	1000P 100V J POLY NI TP
		C912	OCKZTTA003D	SC SAMWHA 250V 1000F M TAPI
		C913	OCKZTTA003D	SC SAMWHA 250V 1000F M TAPI
		C941	0CE108EF630	1000UF KMG 16V M FM5 BULK
		C942	0CE107CF638	"100UF SHL,SD 16V M FM5 TP 5"
		C943	OCK3310W515	330P 500V K B TS
		C944	OCKZTBU003C	SC E 472M 14.0BW7 250V BK7.
		C945	OCKZTBU003C	SC E 472M 14.0BW7 250V BK7.
		C951	0CE228CH630	2200U SHL 25V M FM5
		C952	0CE227CH638	"220UF SHL,SD 25V M FM5 TP 5"
		C953	0CE107CF638	"100UF SHL,SD 16V M FM5 TP 5"
		C954	0CE108ED618	1000UF KMG 10V M FL TP 5
		C971	0CE476EN618	47UF KMG 100V M FL TP 5
		C999	0CE227EL630	220UF KMG 63V M FM5 BULK
DIODEs				
		D201	ODL305029BA	LTL-305DJ-0C2 TP LITEON GRE
		D301	0DS141489AB	1N4148 TP GRANDE DO-34 500M
		D302	0DS141489AB	1N4148 TP GRANDE DO-34 500M
		D303	0DS141489AB	1N4148 TP GRANDE DO-34 500M
		D304	0DS141489AB	1N4148 TP GRANDE DO-34 500M
		D305	0DS141489AB	1N4148 TP GRANDE DO-34 500M
		D306	0DS141489AB	1N4148 TP GRANDE DO-34 500M
		D307	0DS124409AA	1SS244 TP ROHM KOREA
		D308	0DS124409AA	1SS244 TP ROHM KOREA
		D309	0DS124409AA	1SS244 TP ROHM KOREA
		D310	0DS124409AA	1SS244 TP ROHM KOREA
		D311	0DS124409AA	1SS244 TP ROHM KOREA
		D312	0DS124409AA	1SS244 TP ROHM KOREA
		D313	0DS124409AA	1SS244 TP ROHM KOREA
		D314	0DS124409AA	1SS244 TP ROHM KOREA
		D315	0DS124409AA	1SS244 TP ROHM KOREA
		D316	6210TCE003J	BAS2550T BO SUNG 2550MM AXI
		D317	0DS141489AB	1N4148 TP GRANDE DO-34 500M
		D401	0DS141489AB	1N4148 TP GRANDE DO-34 500M
		D402	971-0054	TIN 50MM TAPING
		D512	0DS141489AB	1N4148 TP GRANDE DO-34 500M

DATE: 2002. 01. 23.				
*S	*AL	LOC. NO.	PART NO.	DESCRIPTION / SPECIFICATION
		D701	0DS141489AB	1N4148 TP GRANDE DO-34 500M
		D702	0DS141489AB	1N4148 TP GRANDE DO-34 500M
		D704	0DR150051AA	DMV1500M/F5 ST SGS-THOMSON
		D705	0DR100009CA	RGP10G TP GULF SEMICONDUCTO
		D706	0DR359150AA	BY359F-1500 BK PHILIPS SO
		D709	0DR400409AB	UF4004 TP G.I DO204AL 400V
		D710	0DR320400AA	S3L20U-4004P15 BK SHINDENGE
		D711	0DS141489AB	1N4148 TP GRANDE DO-34 500M
		D712	0DR100009CA	RGP10G TP GULF SEMICONDUCTO
		D714	0DS141489AB	1N4148 TP GRANDE DO-34 500M
		D715	0DS141489AB	1N4148 TP GRANDE DO-34 500M
		D716	0DR140059DA	1N4005TB52 TP LITEON DO41 6
		D717	0DR140059DA	1N4005TB52 TP LITEON DO41 6
		D718	0DR140059DA	1N4005TB52 TP LITEON DO41 6
		D719	0DR100009DA	RGP10J TP GULF SEMICONDUCTO
		D721	0DR100009CA	RGP10G TP GULF SEMICONDUCTO
		D723	0DS141489AB	1N4148 TP GRANDE DO-34 500M
		D724	0DR140059DA	1N4005TB52 TP LITEON DO41 6
		D725	0DS141489AB	1N4148 TP GRANDE DO-34 500M
		D730	971-0054	TIN 50MM TAPING
		D735	0DR140059DA	1N4005TB52 TP LITEON DO41 6
		D741	0DS141489AB	1N4148 TP GRANDE DO-34 500M
		D767	0DR100009DA	RGP10J TP GULF SEMICONDUCTO
		D768	971-0054	TIN 50MM TAPING
		D801	0DS141489AB	1N4148 TP GRANDE DO-34 500M
		D802	0DS141489AB	1N4148 TP GRANDE DO-34 500M
		D900	0DD360000DA	D3SBA60 BK SHINDENGEN 600V
		D902	971-0054	TIN 50MM TAPING
		D903	0DR100009CA	RGP10G TP GULF SEMICONDUCTO
		D905	0DD400709CB	UF4007 TP G.I DO204AL 1000
		D906	0DS141489AB	1N4148 TP GRANDE DO-34 500M
		D908	0DS141489AB	1N4148 TP GRANDE DO-34 500M
		D941	0DD150009CB	RGP15D TP G.I DO204AC 200V
		D942	0DRGS00089A	SB1H100 GENERAL SEMICONDUCT
		D951	0DRGS00110A	UF5403L-5700 GENERAL SEMICO
		D952	0DS141489AB	1N4148 TP GRANDE DO-34 500M
		D961	0DRGS00090A	31GF6L-5701 GENERAL SEMICON
		D962	0DRGS00090A	31GF6L-5701 GENERAL SEMICON
		D971	0DR100009DA	RGP10J TP GULF SEMICONDUCTO
		ZD201	0DZ560009AG	GDZJ5.6B TP GRANDE DO-34 50
		ZD202	0DZ560009AG	GDZJ5.6B TP GRANDE DO-34 50
		ZD203	0DZ560009AG	GDZJ5.6B TP GRANDE DO-34 50
		ZD301	0DZ560009AG	GDZJ5.6B TP GRANDE DO-34 50
		ZD302	0DZ560009AG	GDZJ5.6B TP GRANDE DO-34 50
		ZD401	0DZ560009AG	GDZJ5.6B TP GRANDE DO-34 50
		ZD404	0DZ560009AG	GDZJ5.6B TP GRANDE DO-34 50
		ZD405	0DZ560009AG	GDZJ5.6B TP GRANDE DO-34 50
		ZD406	0DZ560009AG	GDZJ5.6B TP GRANDE DO-34 50
		ZD407	0DZ560009AG	GDZJ5.6B TP GRANDE DO-34 50
		ZD410	0DZ560009AG	GDZJ5.6B TP GRANDE DO-34 50
		ZD411	0DZ560009AG	GDZJ5.6B TP GRANDE DO-34 50
		ZD701	0DZ110009CF	GDZJ11B TP GRANDE DO34 0.5W
		ZD702	0DZ560009AG	GDZJ5.6B TP GRANDE DO-34 50
		ZD705	0DZ510009BE	GDZ5.1B TP GRANDE DO34 500M
		ZD901	0DZ510009BE	GDZ5.1B TP GRANDE DO34 500M
		ZD902	0DZ510009BE	GDZ5.1B TP GRANDE DO34 500M
ICs				
		IC301	0IPRPMJ008A	MTV038N-15EG MYSON 16P DIP
		IC302	0IPRPNS003A	LM1269NA NATIONAL SEMICONDU
		IC303	0IPRPNS009A	LM2469TA NATIONAL SEMICONDU

DATE: 2002. 01. 23.				
*S	*AL	LOC. NO.	PART NO.	DESCRIPTION / SPECIFICATION
		IC304	OIPRPN005A	LM2480NA NATIONAL SEMICONDU
		IC401	OIZZTSZ169A	SS 42PIN ST G-CHASSIS 6KEY
		IC402	OISG240860A	M24C08-BN6 8DIP BK 8K SERIA
		IC402	OISG240860A	M24C08-BN6 8DIP BK 8K SERIA
		IC403	OIKE704200H	KIA7042AP TO-92 TP 4.2 VOL
		IC601	OIPH486600C	TDA4866J 9P ST VERTICAL OUT
		IC701	OIPRPPH008A	TDA4857PS(V2) PHILIPS SDIP3
		IC901	OIPMGSK004A	STR-G8644D(LF1140) SANKEN 5
COILs & COREs				
		FB201	6210TCE003J	BAS2550T BO SUNG 2550MM AXI
		FB301	6210TCE003F	BRD3580B BO SUNG 3580MM RAD
		FB302	6210TCE003J	BAS2550T BO SUNG 2550MM AXI
		FB303	6210TCE003J	BAS2550T BO SUNG 2550MM AXI
		FB304	6210TCE003J	BAS2550T BO SUNG 2550MM AXI
		FB305	6210TCE003J	BAS2550T BO SUNG 2550MM AXI
		FB308	6210TCE003G	BRS3550B BO SUNG 3550MM RAD
		FB309	971-0054	TIN 50MM TAPING
		FB310	6210TCE003A	BRD3510B BO SUNG 3510MM RAD
		FB311	6210TCZ001J	BAS3550T0(125-022J) BO SUNG
		FB312	6210TCZ001J	BAS3550T0(125-022J) BO SUNG
		FB313	6210TCZ001J	BAS3550T0(125-022J) BO SUNG
		FB401	6210TCE003J	BAS2550T BO SUNG 2550MM AXI
		FB402	6210TCE003J	BAS2550T BO SUNG 2550MM AXI
		FB403	6210TCE003J	BAS2550T BO SUNG 2550MM AXI
		FB701	6210TCE003L	BAS3580T BO SUNG 3580MM AXI
		FB703	6210TCE003B	BRS3580B BO SUNG 3580MM RAD
		FB705	6210TCE003L	BAS3580T BO SUNG 3580MM AXI
		FB901	6210TCE003P	BRS2550B BO SUNG 2550MM RAD
		FB904	6210TCE003K	BAS3550T BO SUNG 3550MM AXI
		FB913	6210TCE003P	BRS2550B BO SUNG 2550MM RAD
		FB921	6210TCE003A	BRD3510B BO SUNG 3510MM RAD
		FB922	6210TCE003H	BAS3510T BO SUNG 3510MM AXI
		FB951	6210TCE003J	BAS2550T BO SUNG 2550MM AXI
		L301	0LA0270K119	0.27UH K 2.3*3.4 TP
		L302	0LA0270K119	0.27UH K 2.3*3.4 TP
		L303	0LA0270K119	0.27UH K 2.3*3.4 TP
		L304	0LA1000K119	100UH K 2.3*3.4 TP
		L311	0LA0820K119	0.82UH K 2.3*3.4 TP
		L312	0LA0820K119	0.82UH K 2.3*3.4 TP
		L313	0LA0820K119	0.82UH K 2.3*3.4 TP
		L702	6140TBZ025C	DR14*20 150UH 0.12*25MM 51T
		L703	6140TYZ010E	"LX31 GET DR14*15-C5.2,18.5"
		L705	6140TBZ026C	DR15*18-C9.8 100UH 0.1*30MM
		L901	6200TLS004B	SQE2424 15MH 0.55MM 70T CB7
TRANSISTOR				
		Q501	0TR320209AA	KTC3202-Y(KTC1959) TP KEC T
		Q502	0TR127009AA	KTA1270-Y(KTA562TM) TP KEC
		Q503	0TR319809AA	KTC3198-Y(KTC1815) TP KEC T
		Q701	0TR200009AB	KTC200-Y TP KEC TO92 NPN
		Q706	0TR580301AA	FAIRCHILD KSC5803(TBTU) ST
		Q707	0TR127009AA	KTA1270-Y(KTA562TM) TP KEC
		Q708	0TR127009AA	KTA1270-Y(KTA562TM) TP KEC
		Q709	0TR141300AB	KTD1413 BK KEC TO220I S NPN
		Q710	0TR440009CA	KSP44 TP SAMSUNG
		Q711	0TF630000CA	IRFS630A BK SAMSUNG 200V 6.
		Q712	0TF630000CA	IRFS630A BK SAMSUNG 200V 6.
		Q713	0TF630000CA	IRFS630A BK SAMSUNG 200V 6.
		Q714	0TR319809AA	KTC3198-Y(KTC1815) TP KEC T

DATE: 2002. 01. 23.				
*S	*AL	LOC. NO.	PART NO.	DESCRIPTION / SPECIFICATION
		Q715	0TR319809AA	KTC3198-Y(KTC1815) TP KEC T
		Q716	0TR319809AA	KTC3198-Y(KTC1815) TP KEC T
		Q719	0TF630000CA	IRFS630A BK SAMSUNG 200V 6.
		Q720	0TR390409CA	2N3904 TP SAMSUNG TO92 NPN
		Q722	0TR319809AA	KTC3198-Y(KTC1815) TP KEC T
		Q723	0TR127009AA	KTA1270-Y(KTA562TM) TP KEC
		Q799	0TR920009AB	KSP92 TP SAMSUNG TO92 HIGH
		Q903	0TRFC10003A	FAIRCHILD KSD882Y-S ST TO12
		Q941	0TR319809AA	KTC3198-Y(KTC1815) TP KEC T
		Q942	0TR928009AB	KSA928A-Y TP SAMSUNG TO92L
		Q951	0TR319809AA	KTC3198-Y(KTC1815) TP KEC T
		Q952	0TR928009AB	KSA928A-Y TP SAMSUNG TO92L
		Q953	0TR319809AA	KTC3198-Y(KTC1815) TP KEC T
RESISTORS				
		R201	0RD1001Q609	1K 1/4W(3 5% TA52
		R202	0RD0912Q609	91 OHM 1/4 W (3.4) 5% TA52
		R203	0RD2200Q609	220 1/4W(3 5% TA52
		R204	0RD4300Q609	430 OHM 1/4 W(3.4) 5.00% TA
		R205	0RD1001Q609	1K 1/4W(3 5% TA52
		R206	0RD0912Q609	91 OHM 1/4 W (3.4) 5% TA52
		R207	0RD4300Q609	430 OHM 1/4 W(3.4) 5.00% TA
		R208	0RD2200Q609	220 1/4W(3 5% TA52
		R209	0RD9100Q609	910 1/4W(3 5% TA52
		R210	0RD2200Q609	220 1/4W(3 5% TA52
		R211	0RD2200Q609	220 1/4W(3 5% TA52
		R301	0RD0752Q609	75 1/4W(3 5% TA52
		R302	0RD0752Q609	75 1/4W(3 5% TA52
		R303	0RD0752Q609	75 1/4W(3 5% TA52
		R304	0RD3301Q609	3.30K 1/4W(3 5% TA52
		R305	0RD5601Q609	5.60K 1/4W(3 5% TA52
		R306	0RD5601Q609	5.60K 1/4W(3 5% TA52
		R307	0RD1004Q609	1M OHM 1/4 W (3.4) 5% TA52
		R310	0RD1000Q609	100 1/4W(3 5% TA52
		R312	0RD1001Q609	1K 1/4W(3 5% TA52
		R314	0RD1000Q609	100 1/4W(3 5% TA52
		R315	0RD1000Q609	100 1/4W(3 5% TA52
		R316	0RD1000Q609	100 1/4W(3 5% TA52
		R317	0RD1000Q609	100 1/4W(3 5% TA52
		R318	0RD1000Q609	100 1/4W(3 5% TA52
		R319	0RD4701Q609	4.70K 1/4W(3 5% TA52
		R320	0RD2001Q609	2K 1/4W(3 5% TA52
		R321	0RD2200Q609	220 1/4W(3 5% TA52
		R322	0RD2200Q609	220 1/4W(3 5% TA52
		R323	0RD2200Q609	220 1/4W(3 5% TA52
		R324	0RD2200Q609	220 1/4W(3 5% TA52
		R327	0RD1001Q609	1K 1/4W(3 5% TA52
		R328	0RD1001Q609	1K 1/4W(3 5% TA52
		R329	0RD1001Q609	1K 1/4W(3 5% TA52
		R330	0RD1000Q609	100 1/4W(3 5% TA52
		R331	0RD1000Q609	100 1/4W(3 5% TA52
		R332	0RD1000Q609	100 1/4W(3 5% TA52
		R333	0RD1000Q609	100 1/4W(3 5% TA52
		R334	0RD3303Q609	330K 1/4W(3 5% TA52
		R335	0RD3303Q609	330K 1/4W(3 5% TA52
		R336	0RD3303Q609	330K 1/4W(3 5% TA52
		R337	0RD1000Q609	100 1/4W(3 5% TA52
		R340	0RN1002F409	10K 1/6W 1 TA52
		R341	0RD0332A609	33 OHM 1/2 W (7.0) 5% TA52
		R342	0RD0332A609	33 OHM 1/2 W (7.0) 5% TA52
		R343	0RD0332A609	33 OHM 1/2 W (7.0) 5% TA52

DATE: 2002. 01. 23.				
*S	*AL	LOC. NO.	PART NO.	DESCRIPTION / SPECIFICATION
		R344	ORD0332Q609	33 1/4W(3 5% TA52
		R345	ORD0332Q609	33 1/4W(3 5% TA52
		R346	ORD0332Q609	33 1/4W(3 5% TA52
		R347	ORD1200Q609	120 1/4W(3 5% TA52
		R348	971-0054	TIN 50MM TAPING
		R388	ORD1000Q609	100 1/4W(3 5% TA52
		R389	ORD1000Q609	100 1/4W(3 5% TA52
		R390	ORD1000Q609	100 1/4W(3 5% TA52
		R401	ORD1000Q609	100 1/4W(3 5% TA52
		R402	ORD1002Q609	10K 1/4W(3 5% TA52
		R403	ORD2200Q609	220 1/4W(3 5% TA52
		R404	ORD1000Q609	100 1/4W(3 5% TA52
		R405	ORD1000Q609	100 1/4W(3 5% TA52
		R406	ORD2001Q609	2K 1/4W(3 5% TA52
		R407	ORD2001Q609	2K 1/4W(3 5% TA52
		R408	ORD3302Q609	33K 1/4W(3 5% TA52
		R409	ORD1300Q609	130 1/4W(3 5% TA52
		R410	ORD1300Q609	130 1/4W(3 5% TA52
		R412	ORD2001Q609	2K 1/4W(3 5% TA52
		R413	ORD1001Q609	1K 1/4W(3 5% TA52
		R414	ORD1001Q609	1K 1/4W(3 5% TA52
		R415	ORD1001Q609	1K 1/4W(3 5% TA52
		R416	ORD1801Q609	1.80K 1/4W(3 5% TA52
		R417	ORD1001Q609	1K 1/4W(3 5% TA52
△		R418	ORD3901Q609	3.90K 1/4W(3 5% TA52
		R419	ORD1002Q609	10K 1/4W(3 5% TA52
		R421	ORD1002Q609	10K 1/4W(3 5% TA52
△		R422	ORD1001Q609	1K 1/4W(3 5% TA52
		R423	ORD5600Q609	560 1/4W(3 5% TA52
		R430	ORD1000Q609	100 1/4W(3 5% TA52
		R431	ORD1000Q609	100 1/4W(3 5% TA52
		R432	ORD1000Q609	100 1/4W(3 5% TA52
		R433	ORD2001Q609	2K 1/4W(3 5% TA52
		R434	ORD2001Q609	2K 1/4W(3 5% TA52
		R445	ORD1002Q609	10K 1/4W(3 5% TA52
		R501	ORD0102A609	10 OHM 1/2 W (7.0) 5% TA52
		R508	ORD4702Q609	47K 1/4W(3 5% TA52
		R515	ORD1502Q609	15K 1/4W(3 5% TA52
		R597	ORD3902Q609	39K 1/4W(3 5% TA52
		R598	ORD6801Q609	6.80K 1/4W(3 5% TA52
		R599	ORD0202Q609	20 1/4W(3 5% TA52
		R601	ORD1001Q609	1K 1/4W(3 5% TA52
		R602	ORD1001Q609	1K 1/4W(3 5% TA52
		R603	ORN0390H609	0.39 1/2W 5 TA52
		R604	ORD0101A609	1 OHM 1/2 W (7.0) 5% TA52
		R605	ORD0102A609	10 OHM 1/2 W (7.0) 5% TA52
		R606	ORD1000A609	100 OHM 1/2 W (7.0) 5% TA52
		R607	ORN5101F409	5.10K 1/6W 1% TA52
		R608	ORD3300A609	330 OHM 1/2 W (7.0) 5% TA52
		R610	ORD1101Q609	1.1K OHM 1/4 W (3.4) 5% TA5
		R612	ORN5101F409	5.10K 1/6W 1% TA52
		R613	ORD1801Q609	1.80K 1/4W(3 5% TA52
		R700	ORX0221K607	2.2 OHM 2 W 5% TA62
		R701	ORD1500A609	150 OHM 1/2 W (7.0) 5% TA52
		R702	ORD5601Q609	5.60K 1/4W(3 5% TA52
△		R704	ORD3601Q609	3.60K 1/4W(3 5% TA52
		R705	ORD1602Q609	16K 1/4W(3 5% TA52
		R706	ORN2701F409	2.70K 1/6W 1% TA52
		R707	ORN3301F409	3.30K 1/6W 1% TA52
		R708	ORN1001F409	1K 1/6W 1% TA52
		R709	ORD2202Q609	22K 1/4W(3 5% TA52
		R710	ORD1000Q609	100 1/4W(3 5% TA52

DATE: 2002. 01. 23.				
*S	*AL	LOC. NO.	PART NO.	DESCRIPTION / SPECIFICATION
		R711	ORD1000Q609	100 1/4W(3 5% TA52
		R712	ORD1001Q609	1K 1/4W(3 5% TA52
		R713	ORD1000Q609	100 1/4W(3 5% TA52
△		R714	ORN1501F409	1.5K 1/6W 1 TA52
△		R714-1	ORN3001F409	3K 1/6W 1% TA52
△		R714-2	ORN6200F409	620 1/6W 1% TA52
△		R715	ORD2702Q509	27K OHM 1/4 W(3.4) 2% TA52
		R716	ORD7502Q609	75K 1/4W(3 5% TA52
		R717	ORD5601Q609	5.60K 1/4W(3 5% TA52
		R718	971-0054	TIN 50MM TAPING
		R719	ORD4701Q609	4.70K 1/4W(3 5% TA52
		R720	ORC1205Q609	12M OHM 1/4 W(3.4) 5% TA52
		R721	ORD1001Q609	1K 1/4W(3 5% TA52
		R723	ORD1001Q609	1K 1/4W(3 5% TA52
		R724	ORD1001Q609	1K 1/4W(3 5% TA52
		R725	ORD1001Q609	1K 1/4W(3 5% TA52
		R726	ORD5102A609	51K OHM 1/2 W (7.0) 5% TA52
		R727	ORD1001Q609	1K 1/4W(3 5% TA52
		R728	ORX0272K665	27 OHM 2 W 5% SF
		R729	ORD3000A609	300 OHM 1/2 W (7.0) 5% TA52
		R730	ORB0150K665	0.15 OHM 2 W 5% SF
		R731	ORD1002Q609	10K 1/4W(3 5% TA52
		R732	ORD6802Q509	68K OHM 1/4 W (3.4) 2% TA52
		R733	ORD1002Q609	10K 1/4W(3 5% TA52
		R734	ORD0222A609	22 OHM 1/2 W (7.0) 5% TA52
		R735	ORD1001Q609	1K 1/4W(3 5% TA52
		R736	ORX1501J609	1.5KOHM 1 W 5% TA52
		R737	ORN0560H609	0.56 1/2W 5 TA52
		R738	ORN0560H609	0.56 1/2W 5 TA52
		R740	ORD0271A609	2.7 OHM 1/2 W (7.0) 5% TA52
		R741	ORD1000Q609	100 1/4W(3 5% TA52
		R742	ORD4702Q609	47K 1/4W(3 5% TA52
		R743	ORD2701Q509	2.7K OHM 1/4 W(3.4) 2% TA52
		R744	ORD1001A609	1K OHM 1/2 W (7.0) 5% TA52
		R745	ORD4702Q609	47K 1/4W(3 5% TA52
		R746	ORD2201Q609	2.20K 1/4W(3 5% TA52
		R747	ORD3001Q609	3K 1/4W(3 5% TA52
		R748	ORD4702Q609	47K 1/4W(3 5% TA52
		R749	ORD2201Q609	2.20K 1/4W(3 5% TA52
		R750	ORD3001Q609	3K 1/4W(3 5% TA52
		R752	ORD2201Q609	2.20K 1/4W(3 5% TA52
		R753	ORD3001Q609	3K 1/4W(3 5% TA52
		R754	ORX4300K607	430 OHM 2 W 5% TA62
		R755	ORD0471Q609	4.70 1/4W(3 5% TA52
		R756	ORD2202A609	22K OHM 1/2 W (7.0) 5% TA52
		R757	ORD0222A609	22 OHM 1/2 W (7.0) 5% TA52
		R758	ORN1303F409	130K 1/6W 1% TA52
		R759	ORD1302Q509	13K OHM 1/4 W (3.4) 2% TA52
		R760	ORD5103Q609	510K 1/4W(3 5% TA52
		R761	ORD3001Q609	3K 1/4W(3 5% TA52
		R762	ORD3001Q609	3K 1/4W(3 5% TA52
		R763	ORD3001Q609	3K 1/4W(3 5% TA52
		R764	ORD6801Q609	6.80K 1/4W(3 5% TA52
		R766	ORD6200Q609	620 1/4W(3 5% TA52
		R768	ORD6803A609	680K OHM 1/2 W (7.0) 5% TA5
		R771	ORD3301Q609	3.30K 1/4W(3 5% TA52
		R772	ORD2702Q509	27K OHM 1/4 W(3.4) 2% TA52
		R773	ORD3302A609	33K OHM 1/2 W (7.0) 5% TA52
		R775	ORD4701Q609	4.70K 1/4W(3 5% TA52
		R779	ORD4701Q609	4.70K 1/4W(3 5% TA52
		R782	ORD3301A609	3.3K OHM 1/2 W(7.0) 5.00% T
		R784	ORD1000Q609	100 1/4W(3 5% TA52

DATE: 2002. 01. 23.				
*S	*AL	LOC. NO.	PART NO.	DESCRIPTION / SPECIFICATION
		R789	ORD6800Q609	680 1/4W(3 5% TA52
		R793	ORD4702Q609	47K 1/4W(3 5% TA52
		R797	ORD1501Q609	1.50K 1/4W(3 5% TA52
		R798	ORD2001Q609	2K 1/4W(3 5% TA52
		R799	ORD1502Q609	15K 1/4W(3 5% TA52
		R801	ORD2002Q609	20K 1/4W(3 5% TA52
		R802	ORD3302Q609	33K 1/4W(3 5% TA52
		R803	ORD2001Q609	2K 1/4W(3 5% TA52
		R805	ORD2001Q609	2K 1/4W(3 5% TA52
		R806	ORD4702Q609	47K 1/4W(3 5% TA52
		R808	ORD6802Q609	68K 1/4W(3 5% TA52
		R809	ORMZTWD001G	RWR SMART 1OHM 5 W 5% PD TY
		R813	ORD4302A609	43K OHM 1/2 W(7.0) 5.00% TA
		R814	ORD1002Q609	10K 1/4W(3 5% TA52
△		R816	ORN3601F409	3.6K 1/6W 1 TA52
△		R818	ORN2202F409	22K 1/6W 1% TA52
		R819	ORD4702Q609	47K 1/4W(3 5% TA52
		R831	ORD1002Q609	10K 1/4W(3 5% TA52
		R901	ORD4703A609	470K OHM 1/2 W (7.0) 5% TA5
		R903	ORD5600A609	560 OHM 1/2 W (7.0) 5% TA52
		R904	ORX1503K607	150K OHM 2 W 5% TA62
		R905	ORD2201Q609	2.20K 1/4W(3 5% TA52
		R906	ORD6200Q609	620 1/4W(3 5% TA52
		R908	ORN0220H609	0.22 1/2W 5% TA52
		R910	ORX4702J609	47K OHM 1 W 5% TA52
		R925	ORB0120K607	0.12 OHM 2 W 5% TA62
		R941	ORN0220H609	0.22 1/2W 5% TA52
		R944	ORD4700A609	470 OHM 1/2 W (7.0) 5% TA52
		R945	ORD4701Q609	4.70K 1/4W(3 5% TA52
		R951	ORN0910H609	0.91 1/2W 5 TA52
		R952	ORD4702A609	47K OHM 1/2 W (7.0) 5% TA52
		R953	ORX4700J609	470 OHM 1 W 5% TA52
		R954	ORD4701Q609	4.70K 1/4W(3 5% TA52
		R955	ORD4701Q609	4.70K 1/4W(3 5% TA52
		R956	ORD4702Q609	47K 1/4W(3 5% TA52
		R957	ORD0472A609	47 OHM 1/2 W (7.0) 5% TA52
		R960	ORD2200A609	220 OHM 1/2 W (7.0) 5% TA52
		R967	971-0054	TIN 50MM TAPING
OTHERs				
		F1	430-858C	AFC-520 BAE EUN TA
		F2	430-858C	AFC-520 BAE EUN TA
		F901	0FZZTTH001D	"TIME LAG HBC 3.15A/250V,215"
		J27	ORD0471Q609	4.70 1/4W(3 5% TA52
		J59	ORD1000Q609	100 1/4W(3 5% TA52
		J99	ORD3302Q609	33K 1/4W(3 5% TA52
		RL901	6920TBA001A	DY3MA-DC12 DONGYANG 250VAC
		SC301	6620TBD004A	GZS10-2-101 DUOLING(SANLING
		SC901	6620TKB002A	BAE EUN AC UNIVERSAL 3PIN B
		SG301	6918TRT005A	"SSG-102-A0,1KV SMART RADIAL"
		SG302	6918TRT005A	"SSG-102-A0,1KV SMART RADIAL"
		SG303	6918TRT005A	"SSG-102-A0,1KV SMART RADIAL"
△		SG304	6918TRT005A	"SSG-102-A0,1KV SMART RADIAL"
		SG305	6918TRT005A	"SSG-102-A0,1KV SMART RADIAL"
		SG701	6918TRT005A	"SSG-102-A0,1KV SMART RADIAL"
		SW201	140-058D	SKHV10911A LGEC NON 12 20 H
		SW202	140-058D	SKHV10911A LGEC NON 12 20 H
		SW203	140-058D	SKHV10911A LGEC NON 12 20 H
		SW204	140-058D	SKHV10911A LGEC NON 12 20 H
		SW205	140-058D	SKHV10911A LGEC NON 12 20 H
		SW206	140-058D	SKHV10911A LGEC NON 12 20 H

DATE: 2002. 01. 23.				
*S	*AL	LOC. NO.	PART NO.	DESCRIPTION / SPECIFICATION
		SW207	140-058D	SKHV10911A LGEC NON 12 20 H
△		T701	6174T11003E	"1054A,CB777G LG-PHILIPS 17""
		T702	6170TCZ006A	EE2218 2.3 MH D/FOCUS(CB775
		T703	6170TCZ001D	"EI2218 4.0MH H-DRIVE,EB770G"
		T901	6170TMZ132A	EER3541 150UH V-16PIN EB770
		TH901	6322B00002B	MZ72-9RM290V GAOLI 9OHM 20%
		TH902	6322TA080BA	SCK-084 THINKING 8 ohm 15%
		X401	6202TTB003B	HC-49/U HARMONY RADIAL 12MH

PIN CONFIGURATION

TDA4866J Current Driven Vertical Deflection Booster

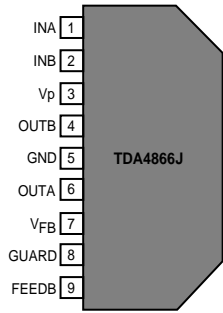
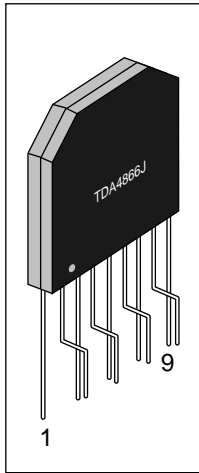

Pin Configuration

PIN	SYMBOL
1	INA
2	INB
3	V _P
4	OUTB
5	GND
6	OUTA
7	V _{FB}
8	GUARD
9	FEEDB

M24C08 Serial I²C BUS EEPROM

PSDIP8 (BN)
0.25mm Frame

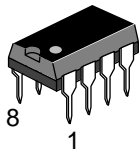

SO8 (MN)
150mil Width

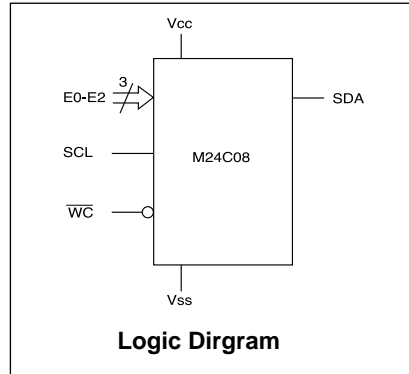

Logic Diagram

SYMBOL	DESCRIPTION
E0-E2	Chip Enable Input
SDA	Serial Data Address Input/Output
SCL	Serial Clock
WC	Write Control
Vcc	Supply Voltage
Vss	Ground

LM2469 Monolithic Triple 9nS high Gain CRT Driver

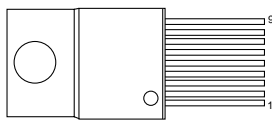

Connection Diagram

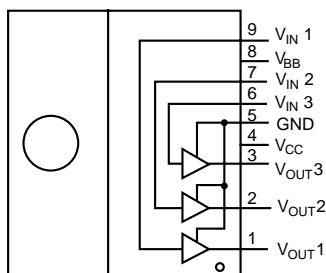

STR-G8644D

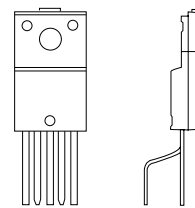

Block Diagram

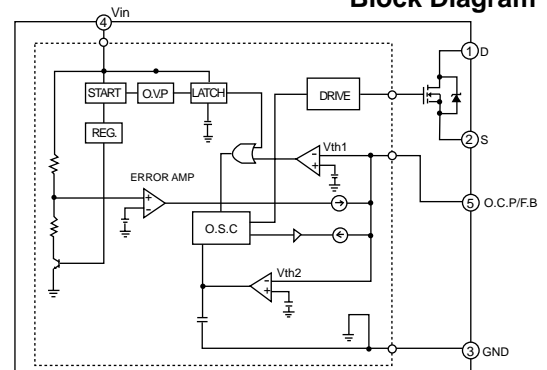

TDA4857 Autosync Deflection Controller

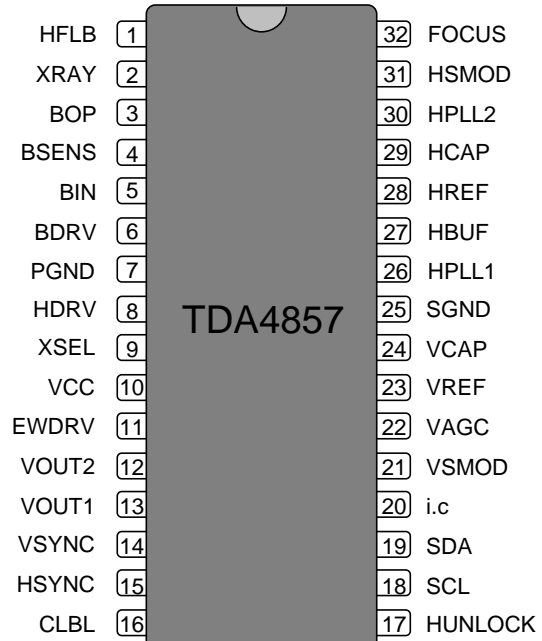
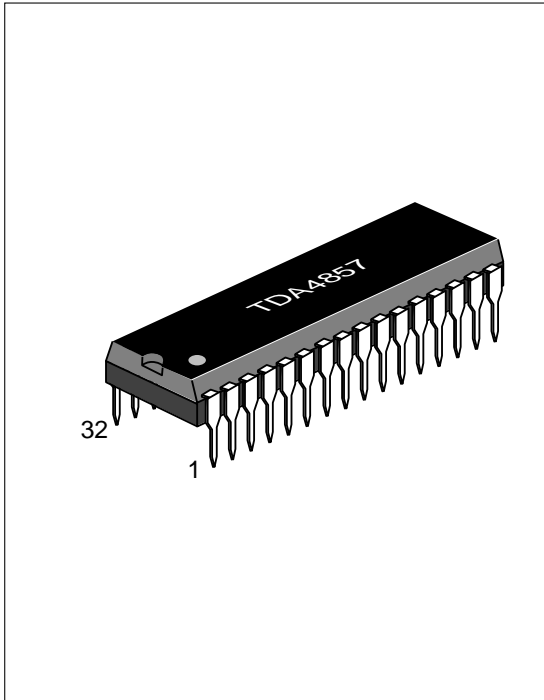

Pin Configuration

PIN	SYMBOL	DESCRIPTION	PIN	SYMBOL	DESCRIPTION
1	HFLB	Horizontal Flyback Input	17	HUNLOCK	H-Synchronization Unlock/Protection/V-Blanking Output
2	XRAY	X-ray Protection Input	18	SCL	I ² C-Bus Clock Input
3	BOP	B ⁺ Control OTA Output	19	SDA	I ² C-Bus Data Input
4	BSENS	B ⁺ Control Comparator Input	20	i.c	Internally connected; nite 1
5	BIN	B ⁺ Control OTA Input	21	VSMOD	Input for EHT Compensation (Via V-Size)
6	BDRV	B ⁺ Control Driver Output	22	VAGC	External Capacitor for V-Amplitude Control
7	PGND	Power Ground	23	VREF	External Resistor for Vertical Oscillator
8	HDRV	Horizontal Driver Output	24	VCAP	External Capacitor for Vertical Oscillator
9	XSEL	Select Input for X-ray reset	25	SGND	Signal Ground
10	Vcc	Supply Voltage	26	HPLL1	External Filter for PLL1
11	EWDRV	EW Waveform Output	27	HBUF	Buffered F/V Voltage Output
12	VOUT2	Vertical Output 2 (Ascending Sawtooth)	28	HREF	Reference Current for Horizontal Oscillator
13	VOUT1	Vertical Output 1 (Descending Sawtooth)	29	HCAP	External Capacitor for Horizontal Oscillator
14	VSYNC	Vertical Synchronization Input	30	HPLL 2	External Filter for PLL2 / Soft Start
15	HSYNC	Horizontal / Composite Synchronization Input	31	HSMOD	Input for EHT Compensation (Via H-Size)
16	CLBL	Video Clamping Pulse / V-Blanking Output	32	FOCUS	Output for Vertical Focus

SCHEMATIC DIAGRAM

EB770G / CB777G
SCHEMATIC DIAGRAM 2002.01.11

— IIC-SDA
- - - IIC-SCL
- - - DDC-SDA
- - - DDC-SCL

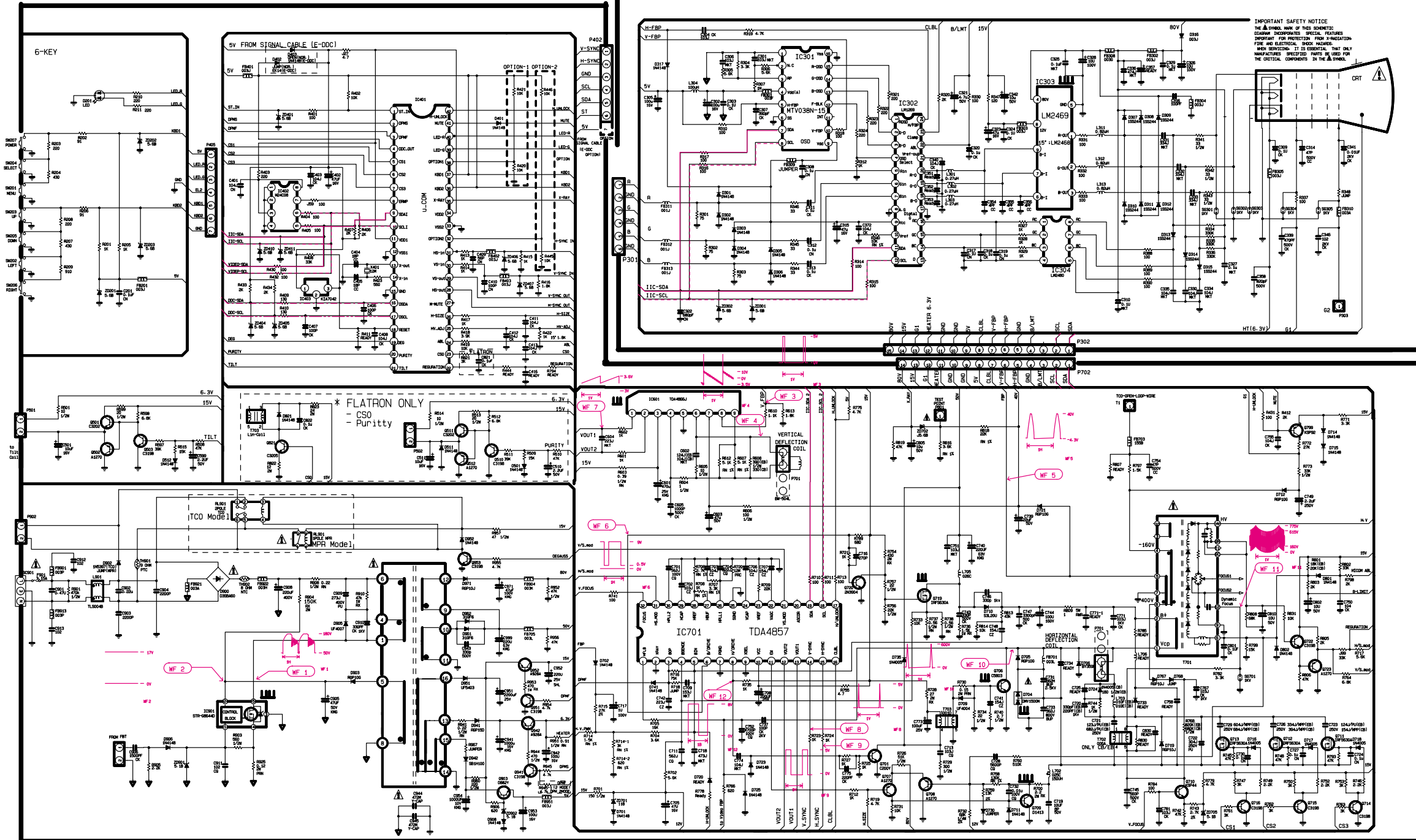

NOTICE
Since this is a basic schematic diagram.
The value of components and some partial connection are
subject to be changed for improvement without notice.

IMPORTANT SAFETY NOTICE
THE Δ SYMBOL MARK OF THIS SCHEMATIC
DIAGRAM INCORPORATES SPECIAL FEATURES
IMPORTANT FOR PROTECTION FROM X-RADIATION,
FIRE AND ELECTRICAL SHOCK HAZARDS. WHEN
SERVICING IT IS ESSENTIAL THAT ONLY
MANUFACTURER SPECIFIED PARTS BE USED FOR
THE CRITICAL COMPONENTS IN THE Δ SYMBOL
MARK OF THE SCHEMATIC.

PRINTED CIRCUIT BOARD

1. CONTROL BOARD (Component Side)

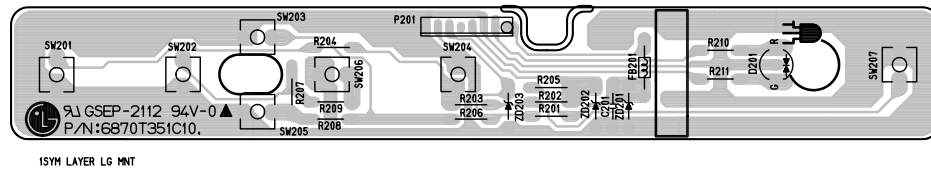

1SYM LAYER LG MNT

2. CONTROL BOARD (Solder Side)

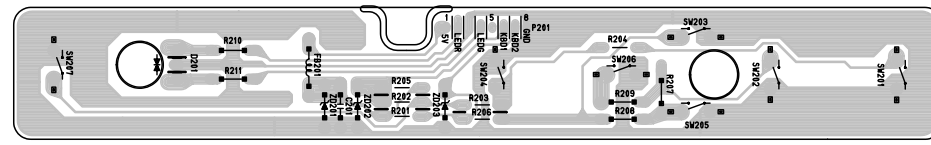

0SYM LAYER LG MNT

3. MAIN BOARD (Component Side)

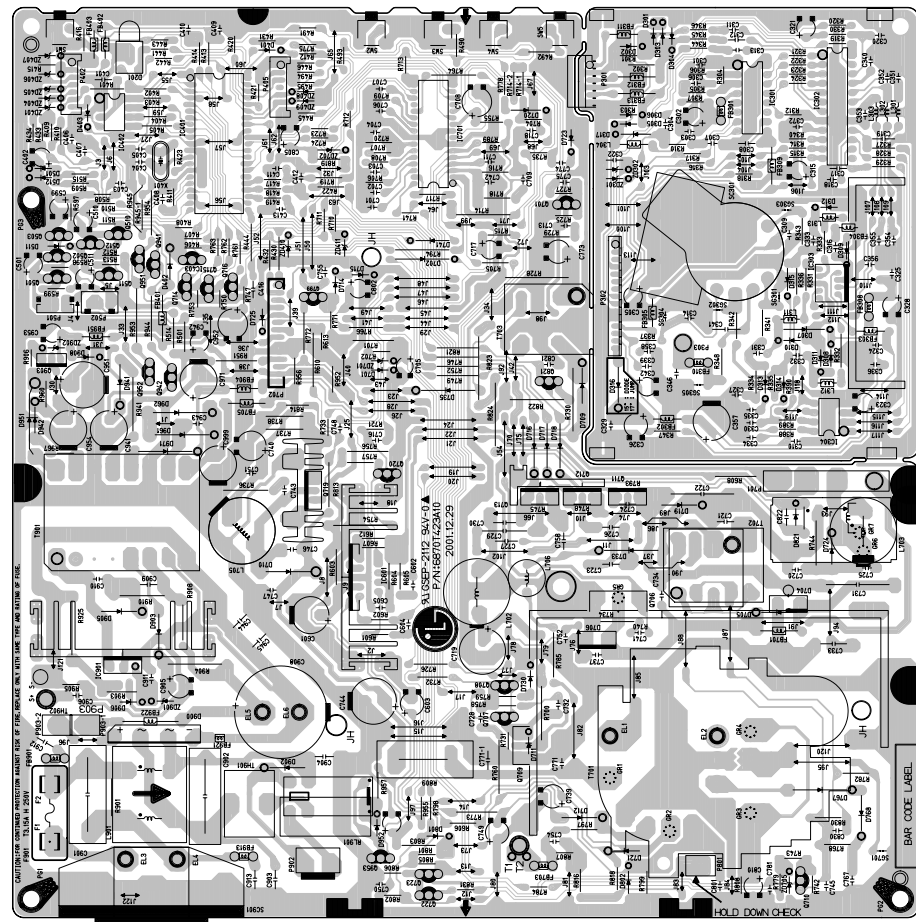

BAR CODE LABEL

4. MAIN BOARD (Solder Side)

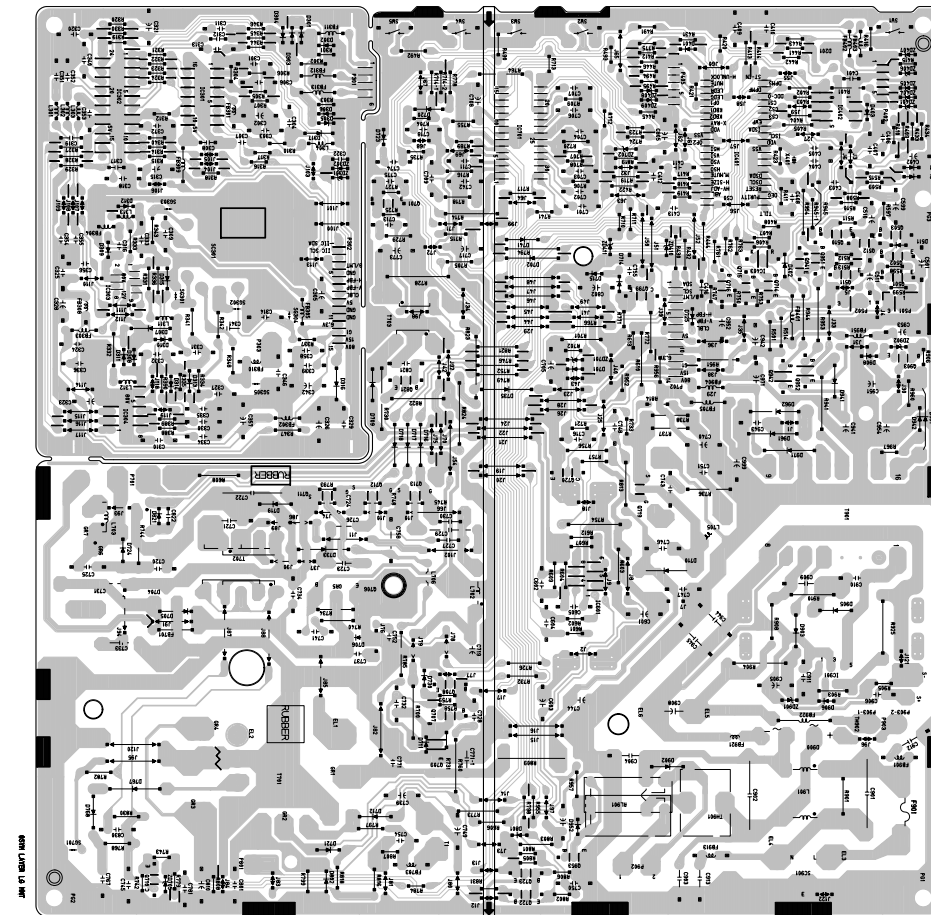



P/NO : 3828TSL080A

Feb. 2002
Printed in Korea

